

GIF VERY-HIGH-TEMPERATURE REACTOR

Proliferation Resistance
and Physical Protection White Paper

August 2022



DISCLAIMER

This report was prepared by the Proliferation Resistance and Physical Protection Working Group (PRPPWG) and the Very-High-Temperature Reactor System Steering Committee of the Generation IV International Forum (GIF). Neither GIF nor any of its members, nor any GIF member's national government agency or employee thereof, makes any warranty, express or implied, or assumes any legal liability or responsibility for the accuracy, completeness or usefulness of any information, apparatus, product, or process disclosed, or represents that its use would not infringe privately owned rights. References herein to any specific commercial product, process or service by trade name, trademark, manufacturer, or otherwise, does not necessarily constitute or imply its endorsement, recommendation, or favoring by GIF or its members, or any agency of a GIF member's national government. The views and opinions of authors expressed therein do not necessarily state or reflect those of GIF or its members, or any agency of a GIF member's national government.

Cover page photos: © Delovely Pics/Shutterstock - © Delovely Pics/Shutterstock - © Pyty /Shutterstock

Preface to the 2021-2022 edition of the SSCs, pSSCs & PRPPWG white papers on the PR&PP features of the six GIF technologies

This report is part of a series of six white papers, prepared jointly by the Proliferation Resistance and Physical Protection Working Group (PRPPWG) and the six System Steering Committees (SSCs) and provisional System Steering Committees (pSSCs). This publication is an update to a similar series published in 2011 presenting the status of Proliferation Resistance & Physical Protection (PR&PP) characteristics for each of the six systems selected by the Generation IV International Forum (GIF) for further research and development, namely: the Gas-cooled Fast Reactor (GFR), the Lead-cooled Fast Reactor (LFR), the Molten Salt Reactor (MSR), the Sodium-cooled Fast Reactor (SFR), the Super Critical Water-cooled Reactor (SCWR) and the Very High Temperature Reactor (VHTR).

The Proliferation Resistance and Physical Protection Working Group (PRPPWG) was established by GIF to develop, implement and foster the use of an evaluation methodology to assess Generation IV nuclear energy systems with respect to the GIF PR&PP goal, whereby: *“Generation IV nuclear energy systems will increase the assurance that they are a very unattractive and the least desirable route for diversion or theft of weapons-usable materials, and provide increased physical protection against acts of terrorism”*.

The methodology provides designers and policy makers a technology neutral framework and a formal comprehensive approach to evaluate, through measures and metrics, the Proliferation Resistance (PR) and Physical Protection (PP) characteristics of advanced nuclear systems. As such, the application of the evaluation methodology offers opportunities to improve the PR and PP robustness of system concepts throughout their development cycle starting from the early design phases according to the PR&PP by design philosophy. The working group released the current version (Revision 6) of the methodology for general distribution in 2011. The methodology has been applied in a number of studies and the PRPPWG maintains a bibliography of official reports and publications, applications and related studies in the PR&PP domain.

In parallel, the PRPPWG, through a series of workshops, began interaction with the Systems Steering Committees (SSCs) and Provisional Systems Steering Committees (pSSCs) of the six GIF concepts. White papers on the PR&PP features of each of the six GIF technologies were developed collaboratively between the PRPPWG and the SSCs/pSSCs according to a common template. The intent was to generate preliminary information about the PR&PP merits of each system and to recommend directions for optimizing its PR&PP performance. The initial release of the white papers was published by GIF in 2011 as individual chapters in a compendium report.

In April 2017, as a result of a consultation with all the GIF SSCs and pSSCs, a joint workshop was organized and hosted at OECD-NEA in Paris. During two days of technical discussions, the advancements in the six GIF designs were presented, the PR&PP evaluation methodology was illustrated together with its case study and other applications in national programmes. The need to update the 2011 white papers emerged from the discussions and was agreed by all parties and officially launched at the PRPPWG meeting held at the EC Joint Research Centre in Ispra (IT) in November 2017.

The current update reflects changes in designs, new tracks added, and advancements in designing the six GIF systems with enhanced intrinsic PR&PP features and in a better understating of the PR&PP concepts. The update uses a revised common template. The template entails elements of the PR&PP evaluation methodology and allows a systematic discussion of the system elements of the proposed design concepts, the potential proliferation and physical protection targets, and the response of the concepts to threats posed by a national actor (diversion & misuse, breakout and replication of the technology in clandestine facilities), or by a subnational/terrorist group (theft of material or sabotage).

The SSCs and pSSC representatives were invited to attend PRPPWG meetings, where progress on the white papers was discussed in dedicated sessions. A session with all the SSCs and pSSCs was organized in Paris in October 2018 on the sideline of the GIF 2018 Symposium. A drafting and reviewing meeting on all the papers was held at Brookhaven National Laboratory in Upton, NY (US) in November 2019, followed by a virtual meeting in December 2020 to discuss all six drafts.

Individual white papers, after endorsement by both the PRPPWG and the responsible SSC/pSSC, are transmitted to the Expert Group (EG) and Policy Group (PG) of GIF for approval and publication as a GIF document. Cross-cutting PR&PP aspects that transcend all six GIF systems are also being updated and will be published as a companion report to the six white papers.

Abstract

This white paper represents the status of Proliferation Resistance and Physical Protection (PR&PP) characteristics for the Very-High-Temperature Reactor (VHTR) reference designs selected by the Generation IV International Forum (GIF) VHTR System Steering Committee (SSC). The intent is to generate preliminary information about the PR&PP features of the VHTR reactor technology and to provide insights for optimizing their PR&PP performance for the benefit of VHTR system designers. It updates the VHTR analysis published in the 2011 report “Proliferation Resistance and Physical Protection of the Six Generation IV Nuclear Energy Systems”, prepared jointly by the Proliferation Resistance and Physical Protection Working Group (PRPPWG) and the System Steering Committees and provisional System Steering Committees of the Generation IV International Forum, taking into account the evolution of both the systems, the GIF R&D activities, and an increased understanding of the PR&PP features.

The white paper, prepared jointly by the GIF PRPPWG and the GIF VHTR SSC, follows the high-level paradigm of the GIF PR&PP Evaluation Methodology to investigate the key points of PR&PP features extracted from the reference designs of VHTRs under consideration in various countries. A major update from the 2011 report is an explicit distinction between prismatic block-type VHTRs and pebble-bed VHTRs. The white paper also provides an overview of the TRISO fuel and fuel cycle. For PR, the document analyses and discusses the proliferation resistance aspects in terms of robustness against State-based threats associated with diversion of materials, misuse of facilities, breakout scenarios, and production in clandestine facilities. Similarly, for PP, the document discusses the robustness against theft of material and sabotage by non-State actors. The document follows a common template adopted by all the white papers in the updated series.

List of Authors

Tomooki Shiba	PRPPWG	Japan Atomic Energy Agency, Japan
Kiyonobu Yamashita		ABC Nuclear, Japan
Keiichiro Hori	PRPPWG	Japan Atomic Energy Agency, Japan
Lap Cheng	PRPPWG	Brookhaven National Laboratory, United States
Benjamin Cipiti	PRPPWG	Sandia National Laboratory, United States
Hans Gougar	VHTR-SSC	Idaho National Laboratory, United States
Gerhard Strydom	VHTR-SSC	Idaho National Laboratory, United States
Christial Pohl	VHTR-SSC	Euratom
Abderrafi Ougouag	VHTR-SSC	Idaho National Laboratory, United States
Hideyuki Sato	VHTR-SSC	Japan Atomic Energy Agency, Japan

Acknowledgements

The current document updates and builds upon the 2011 VHTR PR&PP White Paper. Thanks are due to the original author of the 2011 VHTR PR&PP White Paper, David Moses (PRPPWG, United States), who passed away. This white paper is dedicated to his memory. The in depth reviews by Giacomo G.M. Cojazzi (PRPPWG, European Commission Joint Research Centre), Kevin Hesketh (PRPPWG, National Nuclear Laboratory) and Michael Fütterer (VHTR-SSC, European Commission Joint Research Centre) are particularly appreciated. A special thanks to the PRPPWG Technical Secretaries Gina Abdelsalam and Seoyeong Jeong (OECD-NEA) who ably readied the final manuscript for publication.

Table of contents

1. Overview of Technology 1

1.1. Description of the prismatic VHTR 1

1.2. Description of the pebble bed VHTR 5

1.3. Current system design parameters and development status 7

2. Overview of Fuel Cycle(s)..... 8

3. PR&PP Relevant System Elements and Potential Adversary Targets..... 10

3.1. System elements related to fuel fabrication site for B-VHTR and P-VHTR..... 12

3.1.1. Fresh fuel fabrication 12

3.1.2. Fresh fuel shipment 13

3.1.3. Fresh fuel receiving 13

3.2. System elements related to reactor site of type B-VHTR..... 13

3.2.1. Fresh fuel storage on site 13

3.2.2. Refueling machine for fresh fuel loading and spent fuel discharging 14

3.2.3. Reactor core 15

3.2.4. On-site spent fuel storage..... 16

3.2.5. On-site radioactive waste storage 16

3.2.6. Spent fuel shipping 16

3.3. System elements related to reactor site of P-VHTR..... 16

3.3.1. Fresh fuel storage on site 16

3.3.2. Recirculation of irradiated fuel pebbles 17

3.3.3. On-site spent fuel storage..... 17

3.3.4. On-site radioactive waste storage 17

3.3.5. Spent fuel shipping 17

3.4. System elements related to reprocessing site or final disposal site of spent fuel for B-VHTR and P-VHTR 18

3.5. Diversion targets..... 19

4. Proliferation Resistance Considerations Incorporated into Design 22

4.1. Concealed diversion or production of material 23

4.1.1. Diversion of unirradiated nuclear material items 23

4.1.2. Diversion of irradiated nuclear material items 23

4.1.3. Undeclared production of nuclear material 23

4.2. Breakout..... 24

4.2.1. Diversion of existing nuclear material 25

4.2.2. Production of weapons usable nuclear material..... 25

4.3. Pu Production in clandestine facilities 25

5. Physical Protection Considerations Incorporated into Design 26

5.1. Theft of material for nuclear explosives 26

5.2. Radiological sabotage 26

6. PR&PP Issues, Concerns and Benefits..... 28

7. References 29

APPENDIX 1: VHTR Major Design Parameters 33

APPENDIX 2: Summary of PR relevant intrinsic design features.. 37

List of Figures

Figure 1: Illustration of Coated Particle Fuel in the Prismatic Fuel design	3
Figure 2: GT-MHR Reactor, Cross-Duct and PCU Vessels	4
Figure 3: GT-MHR Fully-Embedded Reactor Building	4
Figure 4: Illustration of Coated Particle Fuel in Pebble Fuel Element	6
Figure 5: X-Energy Xe-100	7
Figure 6: 250 MWt HTR-PM Reactor Building Elevated above Ground Level with Steam Generator; Spent Fuel Storage Not Shown	7
Figure 7: B-VHTR and P-VHTR as well as their fuel elements.....	10
Figure 8: B-VHTR System element.....	11
Figure 9: P-VHTR System element.....	11
Figure 10: Fuel kernel fabrication through dropping uranyl nitrate stock solution	12
Figure 11: Movement of fuel blocks in reactor site of B-VHTR	14
Figure 12: Door valve and refueling machine	15
Figure 13: Neutron detectors and gamma ray detectors installed in the door valve for B-VHTR	Error!
	Bookmark not defined.
Figure 14: Movement of the fuel pebbles.....	17
Figure 15: Plutonium build-up in a PBMR fuel element in an equilibrium core	20
Figure 16: Material Balance Areas and Key Measurement Points of B-VHTR and P-VHTR.....	22

List of Tables

Table 1: Calculated plutonium isotopic fractions for PBMR spent fuel as a function of initial enrichment and discharge burn-up	20
Table 2: Summary.....	21

List of Acronyms

CNEC	China Nuclear Engineering & Construction Group
CoK	Continuity of Knowledge
C/S	Containment/Surveillance
DIV	Design Information Verification
GA	General Atomics
GIF	Generation-IV International Forum
GTHT300C	Gas Turbine High Temperature Reactor 300 for Cogeneration
GT-MHR	Gas-Turbine Modular Helium Reactor
HALEU	High-Assay Low-Enriched Uranium
HEU	Highly Enriched Uranium
HTTR	High Temperature Engineering Test Reactor
HTR	High Temperature Reactor
HTR-PM	High-Temperature Gas-cooled Reactor Pebble-Bed Module
HTR-TN	High-Temperature Reactor-Technology Network
IAEA	International Atomic Energy Agency
INET	Tsinghua University's Institute of Nuclear and New Energy Technology
JAEA	Japan Atomic Energy Agency
KAERI	Korea Atomic Energy Research Institute
KI	Kurchatov Institute
LEU	Low Enriched Uranium
LWR	Light Water Reactor
MA	Minor Actinides
MOX	Mixed Oxide
NED	Nuclear Explosive Device
NHDD	Nuclear Hydrogen Development and Demonstration
NNSA	National Nuclear Security Administration
OKBM	Experimental Design Bureau of Mechanical Engineering in Nizhniy-Novgorod
PBMR	Pebble Bed Modular Reactor
PP	Physical Protection
PR	Proliferation Resistance
PR&PP	Proliferation Resistance & Physical Protection
PWR	Pressurized Water Reactor
RCCS	Reactor Cavity Cooling System
RDD	Radiological Dispersal Device
PCU	Power Conversion Unit
SQ	Significant Quantity
SC-HTGR	Steam Cycle High-Temperature Gas-Cooled Reactor
SSC	System Steering Committee

TRISO	Tri-Isotopic
UOX	Uranium Oxide
VHTR	Very-High-Temperature Reactor

1. Overview of Technology

The Very High Temperature Reactor (VHTR) design descriptions, technology overviews and discussions of issues, concerns and benefits documented in this White Paper establish the bases to support, as the designs evolve, more detailed assessments of proliferation resistance and physical protection (PR&PP).

The assessments will be made using the methodology developed for evaluating PR&PP of the Generation IV reactors [1] with consideration of related reports [2-4]. In April 2017, as a result of a consultation with all the GIF SSCs and pSSCs a joint workshop was organized and hosted at OECD-NEA in Paris. The need to update the 2011 white papers [2] emerged from the discussions and was agreed by all parties and officially launched in November 2017. Therefore, this white paper was written, based on the status of the six GIF system design concepts, considering the designs' evolution in the last decade.

Various versions of the VHTR are under development in several countries that are members of the Generation IV International Forum (GIF), including the People's Republic of China, France, Japan, the Russian Federation, Republic of South Africa, Republic of Korea, Canada, United Kingdom and the United States of America. The VHTR is a helium-cooled, graphite-moderated, graphite-reflected, metallic-vessel reactor that can use various power conversion cycles for electricity production. Co-generation of process steam and high-temperature process heat for chemical process and hydrogen co-production are additional uses for the technology. The major VHTR design options that potentially affect PR&PP can be categorized as follows:

- Prismatic versus pebble fuel
- Direct versus indirect power conversion cycles
- Water versus air cooled Reactor Cavity Cooling System (RCCS)
- Filtered confinement versus low leakage containment
- Underground versus above-ground nuclear islands

The two VHTR basic design concepts considered here are the Prismatic VHTR and the Pebble Bed VHTR. For details, see the reference [5].

1.1. Description of the prismatic VHTR

The safety basis for all the VHTR is to design the reactor to be passively safe, thereby avoiding the release of fission products under all conditions of normal operation and accidents including most of the beyond design basis events. This passive safety aspect of the design should make the VHTR less vulnerable to a threat of "radiological sabotage" through malevolent acts.

There are currently five concepts for the prismatic VHTR under consideration by different GIF countries. The first two of the following have the generic features of low-enriched uranium (LEU) and plutonium-fuelled block-type cores and are sufficiently developed to be considered further here as examples for PR&PP assessment. Except for the second concept discussed below, prismatic VHTRs are being designed assuming the initial use of a once-through LEU fuel cycle.

United States – Work on the Modular HTGR began with General Atomics (GA) in the 1980s. The GA concepts include prismatic cores driving either a direct or indirect cycle, an air-cooled RCCS, filtered confinement, and either a steam cycle (350 MWt MHTGR) or a 600 MWt gas turbine cycle (GT-MHR) [6-8]. The MHTGR was the subject of a pre-application design review by the Nuclear Regulatory Commission. GA has ceased development and design efforts but Framatome (USA), formerly Areva USA, is pursuing a similar concept in the 625 MWt SC-HTGR. The completion of design and licensing of the SC-HTGR is projected to take at least 10 years. Framatome has also completed some work on a higher temperature HTGR

(designated ANTARES) [9, 10], which began as a collaboration in France with other EURATOM participants in the High Temperature Reactor-Technology Network (HTR-TN). The ANTARES Modular HTR is also envisioned to be a 600 MWt cogeneration plant; however, the schedule for completion of research and development depends on end-user engagement. Smaller (<80 MWt) prismatic concepts are being pursued by the UltraSafe Nuclear and StarCore Nuclear companies, mainly for off-grid communities and mines in Canada.

Russian Federation – In cooperation with GA and the U.S. Department of Energy (DOE) National Nuclear Security Administration (NNSA), the Experimental Design Bureau of Mechanical Engineering (OKBM) in Nizhniy-Novgorod with partners at the Kurchatov Institute (KI) and the A.A. Bochvar All-Russian Scientific Research Institute for Inorganic Materials (VNIINM) in Moscow is designing a Russian version of the GA GT-MHR to disposition excess weapon-grade plutonium; however, OKBM is also analyzing alternative fuel cycles for the Russian GT-MHR [11]. The deployment of the Russian GT-MHR is subject to DOE/NNSA joint funding to complete necessary research and development.

Japan – The Japan Atomic Energy Agency (JAEA) continues development work that started under the former Japan Atomic Energy Research Institute (JAERI) on the Gas Turbine High Temperature Reactor 300 for Cogeneration (GTHTR300C) [12], which will scale up the technology from the JAEA 30 MWt High Temperature Engineering Test Reactor (HTTR) into a 600 MWt configuration. The reactor design is based on a prismatic core and can achieve a reactor outlet temperature of 950°C.

Republic of Korea – The Korea Atomic Energy Research Institute (KAERI) is pursuing the Nuclear Hydrogen Development and Demonstration (NHDD) Project; the NHDD reactor is to be limited to 200 MWt (based on the maximum reactor vessel diameter, 6.5 m, that can be fabricated in-country) with no decision yet made as to fuel/core type (pebble bed or prismatic) [13].

United Kingdom – U-Battery Limited is holding the U-Battery project; the U-Battery reactor is to be categorized as small modular reactor with 20 MWt with prismatic core design. The strategic goal is to have a first-of-a-kind U-Battery operating by 2028.

Technology summaries can be found for each vendor-proposed design option in the respective references provided above. SC-HTGR and ANTARES are proposed to be constructed as modules to be built in sets of four or more modules per site. As indicated above, the baseline fuel design for the first modules uses LEU as Tri-Isotropic (TRISO)-coated particle fuel in a once-through fuel cycle. The Russian version of the General Atomics GT-MHR will incorporate excess weapon plutonium in TRISO-coated fuel particles with the addition of erbium containing ¹⁶⁷Er to provide a neutron poison with a thermal neutron capture resonance to guarantee a negative moderator temperature reactivity coefficient.

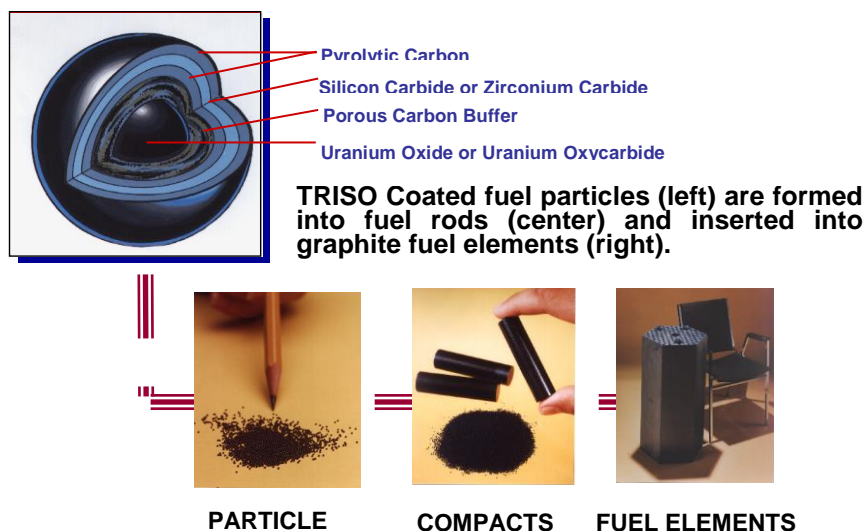

Figure 1: Illustration of Coated Particle Fuel in the Prismatic Fuel design [14].

The TRISO-coated particle fuel (see Figure 1) has a small-diameter (nominally 200-500 μm) spherical ceramic fuel kernel of either uranium oxide or uranium oxycarbide, or mixed oxides of other actinides. The kernel is coated with four coating layers consisting sequentially of low-density porous pyrocarbon (buffer), an inner high density pyrocarbon (IPyC), silicon carbide (SiC)¹ and an outer high density pyrocarbon (OPyC) for better contact with the matrix material which is generally carbon but could also be SiC. The first three coatings on the fuel particles serve as the primary containment preventing the release of fission products. Plant configurations and operating conditions are being designed appropriately to limit fuel temperatures during both normal operations and accident conditions so as to preclude the release of fission products. The coated particles are loaded into fuel compacts (sticks) held together by graphitized carbon or silicon carbide. The fuel compacts are loaded into holes in hexagonal prismatic block fuel elements. Fuel elements are stacked in the reactor core with fissile and neutron burnable poison loadings tailored so that the power distribution is peaked toward the top of the core where the inlet cooling gas has the lowest temperature. The power density is lowest in the bottom of the core where the temperature of the outlet coolant is highest. The fuel and burnable poison loading patterns are specified so that the peak fuel temperature will be below the limit for normal operation, which is 1250°C for TRISO-coated fuel particles with SiC coatings and more than 1600 °C in accident conditions.

Spent fuel is retained in cooled storage containers that are embedded underground and located adjacent to the reactor cavity. Prismatic spent fuel, which is unloaded from the core during periodic refueling shutdowns, can be tracked remotely by cameras viewing the serial numbers on the fuel elements during handling and storage operations. Since each fuel element is loaded with less than 4 kg of LEU, the plutonium content at full burnup (~120 GWD/MT) will be small (~60-70 g) and isotopically degraded compared to weapon-grade plutonium.

The current concepts for the energy utilization from the prismatic VHTRs are based on:

- direct Brayton cycle for electricity generation,
- indirect steam generation for process heat and/or electricity generation,

¹ On-going research focuses on replacing SiC coatings with zirconium carbide (ZrC) coatings to achieve higher temperature limits (~2000°C) for fission product retention during accidents and to reduce diffusion of radioactive-silver.

- indirect heat transfer to process heat user (e.g., Hydrogen production).

The vessel configuration for the direct cycle GT-MHR is illustrated in Figure 2, and the reactor building option for the GT-MHR is illustrated in Figure 3. Although the GT-MHR is no longer under development, the plant layout for the Framatome SC-HTGR is very similar.

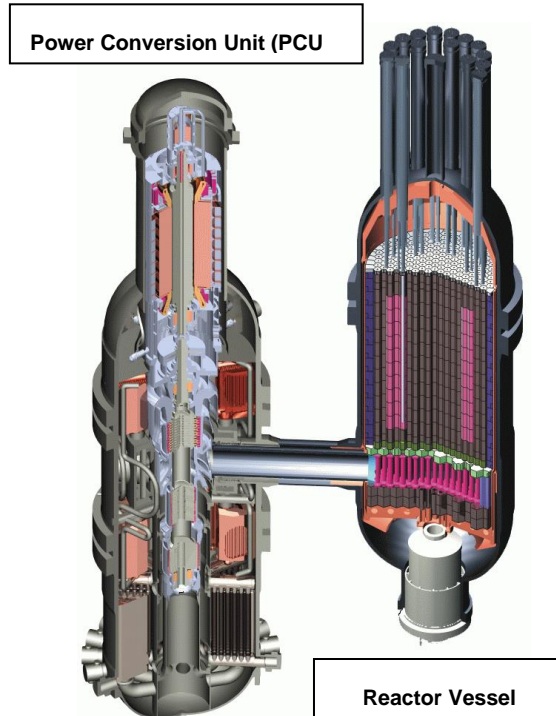

Figure 2: GT-MHR Reactor, Cross-Duct and PCU Vessels [2].

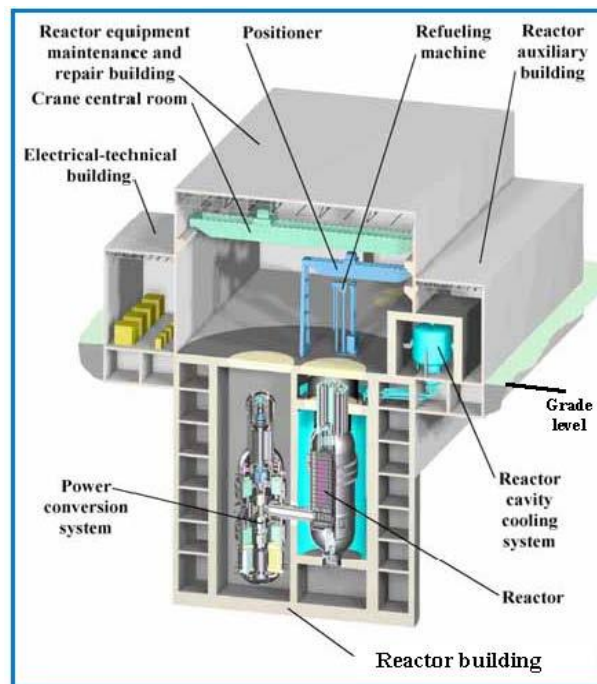

Figure 3: GT-MHR Fully-Embedded Reactor Building [2].

In many modular VHTRs under development, the reactor vessel and power conversion unit are placed underground, which enhances physical protection for the plant.

1.2. Description of the pebble bed VHTR

All modern pebble bed VHTR concepts trace their design features to the HTR Module 200 MWt concept developed in Germany in the 1980s. There is currently one national program for a pebble bed VHTR and one commercial endeavor in the United States.

South Africa – South Africa pursued development of the Pebble Bed Modular Reactor (PBMR) until 2010, when owing to funding constraints Cabinet moratorium was placed on the project thereby putting its assets and intellectual property under care and maintenance. The PBMR had a rated capacity of 165 MWe, featured a thermal power of 400 MWt and a direct power conversion with a gas turbine operating with a helium outlet temperature of 900 °C. In 2016, Eskom commenced the development of the Advanced High Temperature Reactor, a 100MWt/50MWe proof-of-concept design with molten salt energy storage and helium outlet temperature of 1200 °C.

Subject to Cabinet approval, discussions are ongoing to revive research and development of the Pebble Bed Modular Reactor programme in line with Government policy position as stated in the Nuclear Energy Policy of 2008. The research and development work is expected to consolidate previous efforts, including the work progressed by Eskom for Advanced High Temperature Reactor (AHTR) technology development.

United States – The 200 MWt Xe-100 is a concept under development by the X-Energy company with some support from the US Government [15-17]. It features a recirculating pebble bed core driving a steam cycle. Formal conceptual design activities have started, and X-Energy is also pursuing TRISO fuel manufacturing capability with Centrus. X-Energy is pursuing deployment of the first commercial reactor by 2030.

People's Republic of China (PRC) – The China Huaneng Group in a consortium with China National Nuclear Corporation subsidiary China Nuclear Engineering Corporation and Tsinghua University's Institute of Nuclear and New Energy Technology has been developing construction of the 2 x 250 MWt, steam-cycle High-Temperature Reactor-Pebble-bed Module (HTR-PM) [18, 19]. It has been connected to the grid in December 2021; the HTR-PM, which builds on the success of the Tsinghua University's HTR-10 test reactor [20], is being constructed in two module units producing 500 MWt and 210 MWe. Each power plant comprises two reactor modules with individual steam generators sharing a single turbo-generator. A 6-module, 600 MWt generating station is undergoing design. The 6-module plant is sized to fit into a reactor building roughly that of a large PWR.

The pebble bed reactors share the same passive safety features as the prismatic VHTRs but have less excess reactivity due to on-line refueling. The LEU fuel for the pebble bed VHTRs is TRISO-coated particles compacted into tennis ball size spheres, as illustrated in Figure 4.

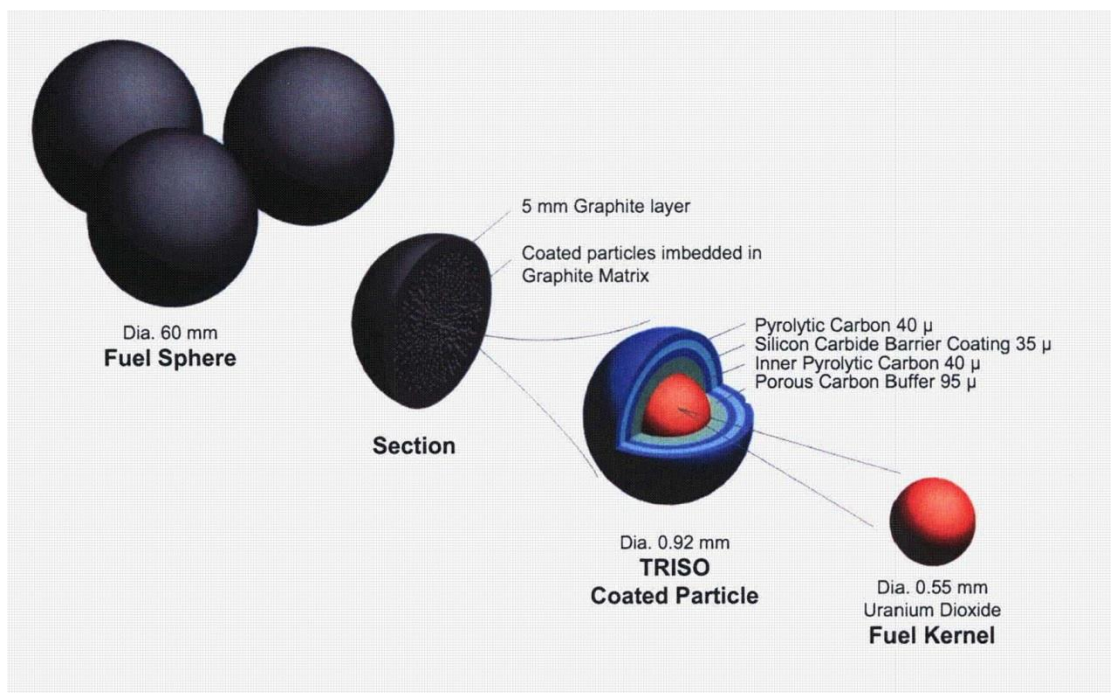

Figure 4: Illustration of Coated Particle Fuel in Pebble Fuel Element [2, 15].

The pebble fuel is usually not tracked individually by serial number as in the prismatic core, but elements are counted, characterized, and checked following each of multiple recirculations until they achieve the target burnup based on radioactivity measurements. Following several passes of each pebble through the core during on-line pebble recirculation, when measured pebble activity indicates sufficient burnup, the pebble is transferred to a storage container with a record kept of the number of pebbles transferred. Once pebble spent fuel is in the storage container, radiation monitoring is used to quantify by inference the amount of spent fuel present since, with no more than 0.12 grams of plutonium per pebble, it would take several tens of thousands of pebbles (or several metric tons by total mass and cubic meters by volume) to be diverted to constitute the basis for recovering a significant quantity of plutonium². Further, at a burnup around 90 GWD/MT for the HTR-PM or 150 GWD/MTMT for the Xe-100, the plutonium isotopic composition in the pebble spent fuel is degraded significantly compared with that of weapon-grade plutonium.

The reactor vessel arrangement for the Xe-100 concept is illustrated in Figure 5, showing the associated spent fuel storage location to the right of the reactor vessel. The reactor vessel and vessel arrangement for the 250 MW-thermal steam-cycle PRC HTR-PM are illustrated in Figure 6, with the steam generator below and to the left of the reactor vessel.

² “Significant Quantity” SQ, as defined by the IAEA, is “the approximate amount of nuclear material for which the possibility of manufacturing a nuclear explosive device cannot be excluded”. For Pu (containing less than 80% Pu-238) and for U-233 a SQ corresponds to 8 kg, A SQ is 25 kg for U enriched in U-235 at 20%, or above, 75 kg for U enriched below 20% in U-235 (or 10 t for natural U or 20 t for depleted U). See the IAEA Safeguards Glossary for all details: International Atomic Energy Agency, “IAEA Safeguards Glossary, 2001 Edition”, International Nuclear Verification Series No. 3, Vienna, Austria, 2002.

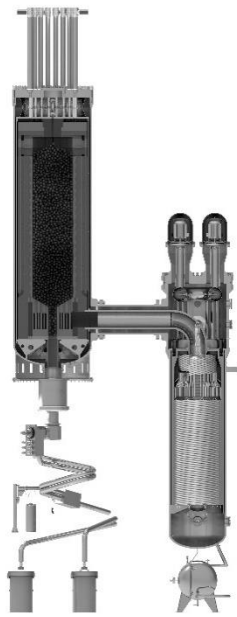

Figure 5: X-Energy Xe-100 [21].

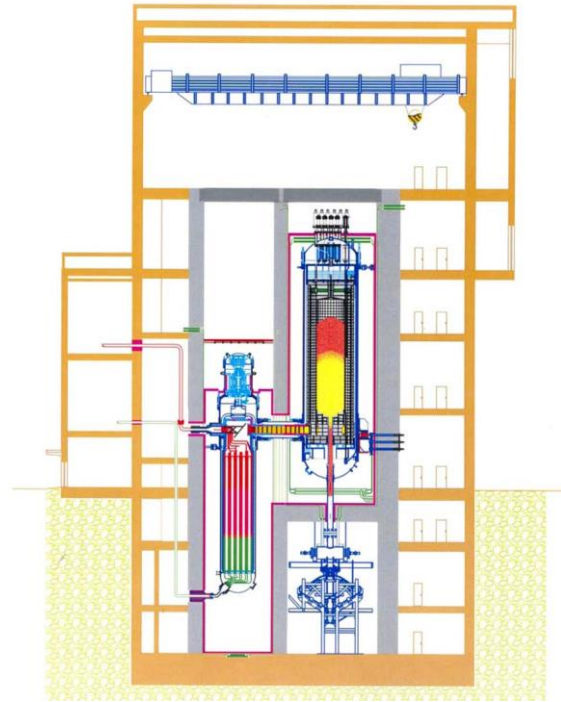

Figure 6: 250 MWt HTR-PM Reactor Building Elevated above Ground Level with Steam Generator; Spent Fuel Storage Not Shown [2].

1.3. Current system design parameters and development status

The key design parameters for selected concepts (both prismatic and pebble bed) are presented in Appendix 1: VHTR.A.

2. Overview of Fuel Cycle(s)

A comparison of the vendor-proposed VHTR fuel cycle parameters is provided in Appendix 1: VHTR.B. The information in Appendix VHTR.B is taken either from the references given in Section 1 or is inferred from these references where no specific information has been provided by the vendors.

The baseline fuel cycle for the first generation VHTR is the once-through fuel cycle using LEU fuel enriched to between 8 and 16% U-235. The Russian Federation is simultaneously pursuing the GT-MHR as a “deep-burn” option for weapon-grade plutonium (Pu) disposition. The use of highly enriched uranium (HEU) as HTGR fuel, as was done in the past, is no longer acceptable by many nation states because exporting Special Nuclear Material (SNM), or fissile production technology, is considered a controlled export. However, this policy position is not universally held by all states. The same is true of separated plutonium, even when considering a deep-burn fuel cycle as the one currently being considered by the Russian Federation. Some regulatory authorities allow for separated plutonium whereas others do not due to their own domestic policy, export control regulations, or both. Additionally, under the regulatory framework of some states, the HEU and separated Pu require heightened safeguards and security measures, compared to LEU, which incurs added complexity and cost to the fuel cycle.

X-Energy is considering a range of other fuel cycle options for future reactor deployments including plutonium disposition and transuranic elements (TRU)/MA transmutation and the use of thorium (Th-232) as a fertile component for high-conversion fuel. Each of these options, including the so-called deep-burn options, is currently based on an initial once-through irradiation without recycle, although technologies to reprocess and recycle TRISO fuel are also under consideration or initial development and were studied extensively in the past at laboratory and pilot scale for HEU/Th fuels. The ongoing research and development and the historic experience provide a reasonably sound basis to have confidence in the ability to close the VHTR fuel cycle in the future, if needed. Note that those alternative fuel cycles are a task in the GIF VHTR Fuel and Fuel Cycle Project.

The fuel cycle options for VHTRs can be categorized in three ways described below.

First, VHTRs can operate with either pebble or prismatic fuels. Pebble bed reactors operate with on-line refueling. This enables operation with very low excess reactivity and without burnable neutron poison, typically only sufficient to overcome the neutron poisoning effects of xenon that occur following power reductions. Prismatic fueled reactors require periodic refueling outages and thus operate with substantially higher average excess reactivity compensated by burnable neutron poison, but allow substantially greater flexibility in fuel zoning and shuffling.

Second, VHTR fuel cycles can be categorized by the types of fuel particles used, as follows:

- LEU fuel particles with or without natural uranium fertile fuel particles.
- Pu fuel particles.
- TRU or MA fuel particles.
- U-233 fuel particles (or U-233 with U-238).
- Thorium (or thorium with uranium) fertile fuel particles.
- Pu/Th-232 and/or Pu/U-238 in mixed oxides (MOX).

The first four types of particles contain fissile isotopes that are required to support criticality of the reactor. The LEU particles also contain the fertile isotope U-238 and in some designs may contain fertile particles of natural uranium. However, with the VHTR's thermal spectrum, thorium has somewhat better properties as a fertile isotope, so, for core designs that add fertile material, thorium fuel particles may replace the use of natural uranium in the future. This thorium may be mixed with a small amount of uranium to dilute and “denature” the fissile U-233 produced by neutron absorption in thorium. In general, it can be expected that future VHTR

reactors will operate with fuels composed of some mix of the six particle types listed above. Each particle type involves specific technical issues for fabrication, with some being more challenging than others.

Third, VHTR fuel cycles can be categorized by whether or not the spent fuel is discarded or recycled. Recycle may occur with either aqueous or pyroprocessing methods, and recycled materials may be returned to VHTRs or LWRs or sent to fast reactors. Either method would require a 'head-end' process to de-consolidate the coated particles from the graphite and 'crack' the silicon carbide coating so that the heavy metal kernel can be leached. This is technically possible but has not been demonstrated on a commercial scale

Except for the LEU once-through cycle and the historic testing and use of HEU/Th, all other fuel cycles for the VHTR represent future possibilities given also that there is likely to be a requirement for several years of effort and a significant financial investment for supporting research (including irradiation testing of laboratory-scale, pilot-scale and industrial-scale fabrications of candidate fuels) to qualify the fuel forms for the alternative fuel cycles. Currently, only LEU fuel is being tested for qualification, so alternative fuel options are likely years away in development. Regarding the reprocessing of VHTR fuels, the PUREX process can be applied with specific head end processes to separate the fuel particles from the graphite matrix and fuel kernels from the coatings. This complexity of reprocessing leads to difficulty in Pu extraction, which increases proliferation resistance. The process yields large quantities of ¹⁴C-contaminated CO₂ or carbon sludge that must be treated, conditioned, and disposed safely. Note that the reprocessing technology for irradiated Thorium fuel (THOREX process, similar to the PUREX process) is ready for application, but its demonstration at an industrial level has not been carried out yet.

The challenges of realizing such fuel cycles at the commercial level have become major R&D topics internationally, and many efforts are ongoing. For one of those examples, see the reference [22]. In addition, the waste graphite and SiC can be decontaminated to reduce waste volume. Studies on the subject are ongoing in several countries.

3. PR&PP Relevant System Elements and Potential Adversary Targets

Although the shape of the fuel is different for the block type very high temperature gas reactor (B-VHTR) and pebble bed type very high temperature gas reactor (P-VHTR), their safeguards features and the physical protection features have some similarities because the fuel is made from a mixture of coated fuel particles with graphite powder that is sintered. Figure 7 shows sketches of reactors of the B-VHTR and P-VHTR types and their respective fuel elements.

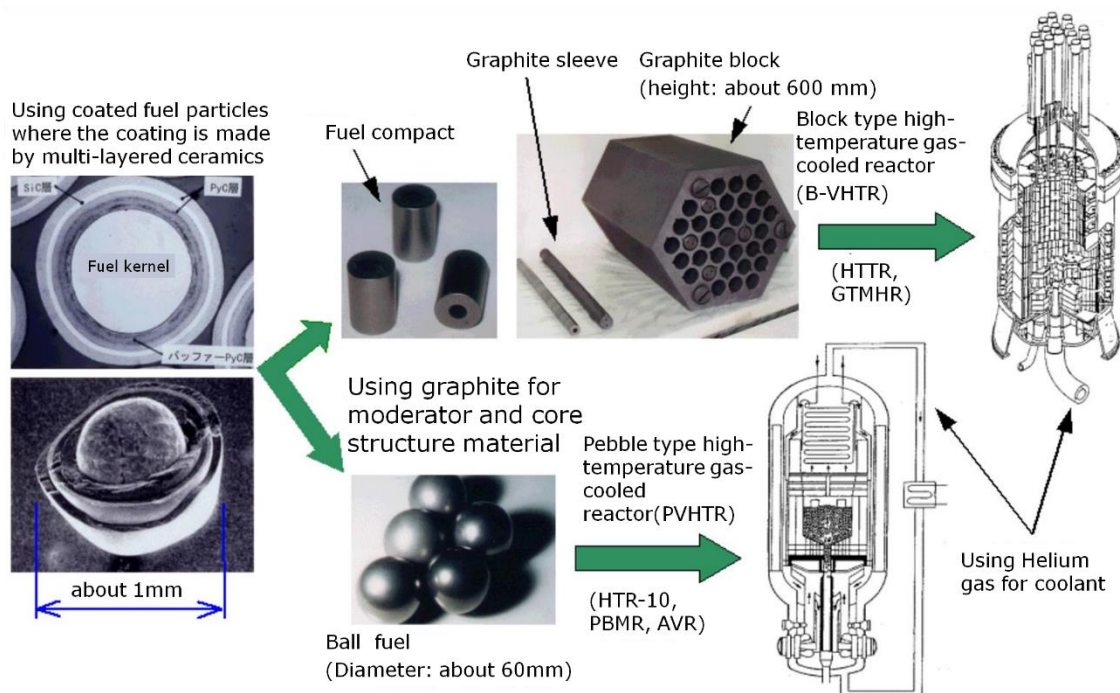

Figure 7: B-VHTR and P-VHTR as well as their fuel elements.

In order to retrieve a significant quantity of nuclear material from used VHTR fuels, it is necessary to process metric tons and tens of cubic meter quantities of carbon-encased nuclear fuel using either grind-leach, burn-leach or electrolysis in nitric acid, the technology for which is still not matured to industrial level. The cost of removing and storing the large volume of separated graphite should be considered a proliferation resistance feature. Such large quantities are a necessity to retrieve enough weapons usable fissile material and would be difficult to conceal by a proliferating state.

The use of LEU is currently planned in both B-VHTR and P-VHTR due to its low proliferation characteristics. For states that own their own domestic enrichment capability, the raw LEU material for fresh fuel fabrication is more attractive than the fabricated graphite fuel forms (block or pebble since a lower level of effort would be required for its diversion or acquisition from the system elements at fuel fabrication sites or product side of reprocessing sites etc. For states that import the as-fabricated graphite fuels, the attractiveness may be considered similar between the fresh and spent fuels. This is because a similar amount of effort is required to crack the SiC barrier as discussed previously.

It is noteworthy from a security standpoint, INFCIRC/225 (the IAEA Recommendations on nuclear security) allows some credit for radioactive source term regarding the degree of physical protection. However, once a Category II (i.e., U-235/U < 20%) fuel has decayed sufficiently, the security threat and categorization are the same between fresh and used fuel. The Standard also prescribes an elevated security posture for High Assay Low Enriched Uranium (HALEU), 10 wt.% ≤ U-235/U < 20 wt.%. For example, it specifies that HALEU be

stored in the facility’s protected area, as opposed to the limited access area. It also calls out the need for increased communication and verification for transport. Similarly, it elevates the importance of armed guards (i.e., a dedicated security organization) during transport and storage at facilities.

The "system elements" for B-VHTR and P-VHTR are shown in Figure 8 and Figure 9, respectively.

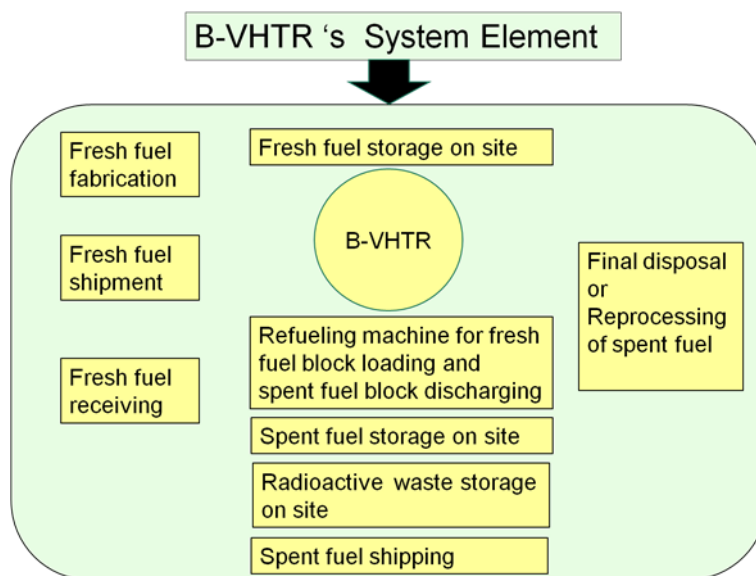

Figure 8: B-VHTR System element.

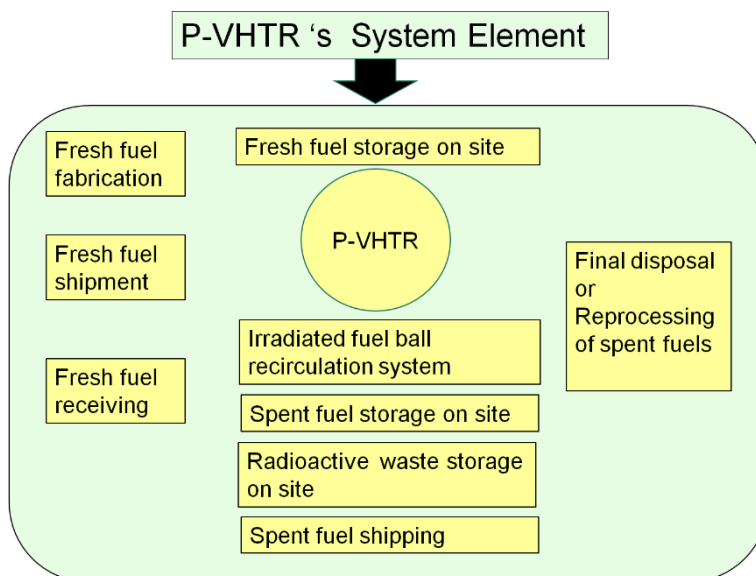

Figure 9: P-VHTR System element.

The system elements of the both VHTR types are principally the same except for the unloading and reloading of fuel blocks of the B-VHTR and the recirculating fuel spheres of the P-VHTR. The common system elements for both VHTRs are discussed in the following.

3.1. System elements related to fuel fabrication site for B-VHTR and P-VHTR

3.1.1. Fresh fuel fabrication

The raw constituents of fresh fuel (Uranium hexafluoride, nitrate, or oxide of LEU, LEU/Pu (MOX), LEU/Th or Pu / Th(MOX)) are brought into the fuel fabrication facility. Fuel elements (fuel compacts for block type fuel or fuel spheres) containing TRISO-coated fuel particles sintered with graphite powder are manufactured and shipped out to reactor sites. LEU is currently intended for use in B-VHTR and P-VHTR due to its higher proliferation resistance, specifically with respect to material attractiveness. Fuel based on LEU / Th, LEU/Pu (MOX) or Pu / Th may be used in future VHTRs. Raw material for fresh fuel fabrication is the most attractive target over the entire set of system elements of B-VHTR and P-VHTR, from fuel fabrication to final disposal, since it would require the least effort to divert, process and use for fabrication of NEDs (hence it will require more attention and protection). However, it should be noted that the material type will be the same if present in the fuel fabrication facility or in the fresh fuel in terms of the IAEA safeguards target material. In any case the material will require further processing for use in a NED unless it is already in suitable form. See the discussion of the section 2 of the reference [23]. It should be also noted that safeguarding bulk material is more complicated than safeguarding material in items forms.

The fuel kernels of the coated fuel particles are manufactured by dropping uranyl nitrate stock solution into ammonia water as shown in Figure 10.

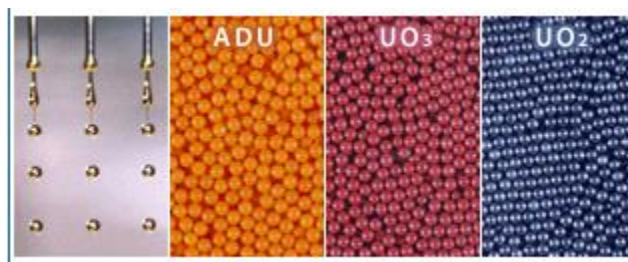

Figure 10: Fuel kernel fabrication through dropping uranyl nitrate stock solution [24].

Implementation of adequate measures of Containment and Surveillance (C/S) and physical protection needs to be enforced over those raw constituents of fresh fuel according to the grade of nuclear material such as LEU, LEU/Th, LEU/Pu, and Pu / Th.

Every fuel block of B-VHTR is stamped with identification numbers (IDs). On the other hand, there is no ID on fuel pebbles of P-VHTR, which requires a different safeguards approach as B-VHTR (item-based safeguards can be applied for B-VHTR). In contrast, quasi-bulk type safeguards are needed for P-VHTR. In the past, however, there have been cases where safeguards were implemented by assigning IDs to pebbles at the research reactor level, but not for online monitoring during the re-loading procedure. As one of the ongoing efforts, see the reference [25]. Fabrication also involves scrap recovery and recycling within the supplier's fuel fabrication facility. Non-recoverable scrap materials are stored for disposition as low-level radioactive waste. The isotopes U-235, U-233 and Pu are attractive for adversaries aiming for manufacturing NEDs. However, once these nuclear materials are encased in graphitized carbon as the kernel of coated fuel particles of fuel elements of both B-VHTR and P-VHTR, their use in NEDs poses major difficulties for an adversary. The separation of the kernel from coated fuel particles is difficult due to the stable chemical and mechanical characteristics of carbon and SiC layers. Techniques such as grind-leach or burn-leach or electrolysis in nitric acid are necessary, but they have not yet been matured to industrial level. Also, in order to acquire significant quantities of nuclear materials, metric tons and tens of cubic meter quantities of carbon and SiC layers from the coated fuel particles and the graphite matrix surrounding them must be processed.

3.1.2. Fresh fuel shipment

Fuel rods for B-VHTR and fuel pebbles for P-VHTR are put into containers and shipped from fuel fabrication facilities to reactor sites. Adequate C/S system such as sealing and PP need to be applied to containers to ensure continuity of knowledge according the sensitivity grade of the nuclear material being shipped. Note that there are no current domestic or internationally licensed shipping container for transporting large quantities of HALEU fuels.

3.1.3. Fresh fuel receiving

Broken fresh fuel elements should be segregated and must be stored separately by the user for shipment back to the supplier for recycling as un-irradiated scrap. The C/S system for fresh fuel shipment must be confirmed upon fresh fuel receiving. The nuclear material in the broken fresh fuel elements is not attractive because the amounts are small and the material is still in the form of coated fuel particles.

3.2. System elements related to reactor site of type B-VHTR

PR of B-VHTR is based on item accountancy. It is possible to imprint an ID on each fuel block, so the safeguards approach has many similarities with the safeguards of LWRs. All system elements related to a reactor site are confined within the reactor building as shown in Figure 11 [26]. All movements of fuel can be monitored by the surveillance cameras. Fuel storage racks of the fresh fuel storage and spent fuel storage areas are sealed after handling fuel therein. Fuel inventory in the reactor core is verified by measuring the fuel flow with detectors in the door valve. Movement of the fuel handling machine is slow due to its mass of more than 100 tons. This movement can be followed by the surveillance cameras whose data should be continuously transferred to the safeguards inspectorate to mitigate potential cyber-attacks.

3.2.1. Fresh fuel storage on site

Fuel blocks are assembled by inserting fuel rods into pre-formed holes in the graphite blocks in the reactor building. The on-site movement of fuel blocks of the B-VHTR is shown in Figure 11. The fuel blocks are stored in the fresh fuel storage rack until such time as the blocks scheduled for reloading are returned to the reactor core. An adequate C/S system such as surveillance cameras and PP should be applied to the fresh fuel storage area, the refueling machine, and the spent fuel storage area for continuity of knowledge.

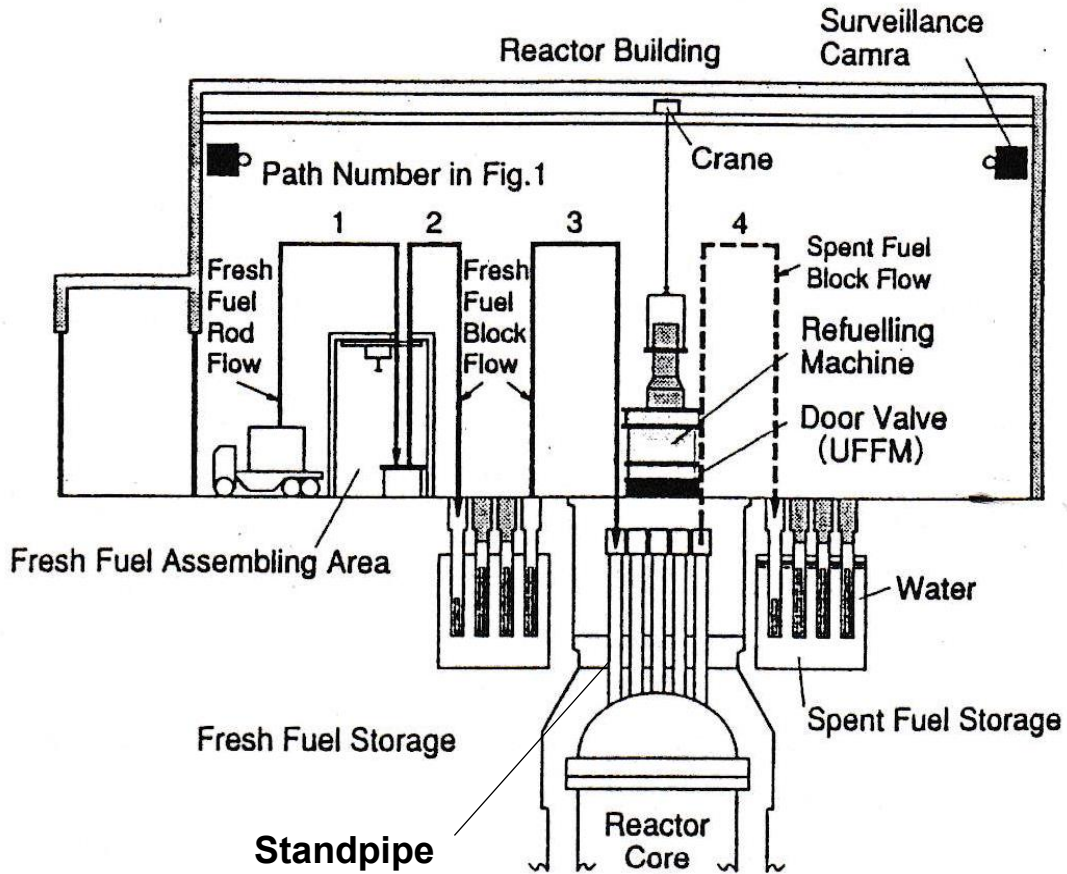

Figure 11: Movement of fuel blocks in reactor site of B-VHTR [26].

3.2.2. Refueling machine for fresh fuel loading and spent fuel discharging

This paragraph refers to HTTR as this is considered fully representative of B-VHTR [27].

The fresh fuel blocks are taken into the refueling machine from the fresh fuel storage, and then the refueling machine is lifted and moved onto the door valve over the reactor with the crane. The fresh fuel blocks are loaded into the vertical empty space from where the spent fuels have been taken out. The IDs of fuel blocks are confirmed at time of loading of fresh fuel. The spent fuel blocks in the reactor are taken into the revolver-rack of the refueling machine and moved to a spent fuel storage facility by the crane before the fresh fuels are loaded. The control rod driving device and the pair of control rods must be removed before refueling. Replaceable side reflectors and fuel blocks are handled using the refueling machine. They are passed through the door valve and the stand pipe at the upper part of the reactor core for any refueling. Fuel reloading in light water reactors (LWRs) is performed in water that provides a radiation shielding effect. However, the coolant of B-VHTR is helium and has no radiation shielding effect. For this reason, the fuel exchange for B-VHTR is performed by remote control of the gripper of the refueling machine, since the fuel cannot be directly viewed. It is also necessary to incorporate a radiation shielding function in the refueling machine because it will contain the spent fuel block in the revolver-rack. For this reason, its mass exceeds 100 tons. When the refueling machine is moved from the upper part of the reactor, the coolant (helium) in the reactor should not be allowed to leak. A door valve is provided between the refueling machine and the standpipe to prevent leakage of the coolant (helium) in the reactor to outside. The position of door valve is shown in Figure 12 [27]. Neutron detectors and gamma ray detectors are attached to the door valve, since the door valve is necessary to move out core components (anything such as spent fuel blocks, replaceable side reflectors and irradiated experimental material from the reactor).

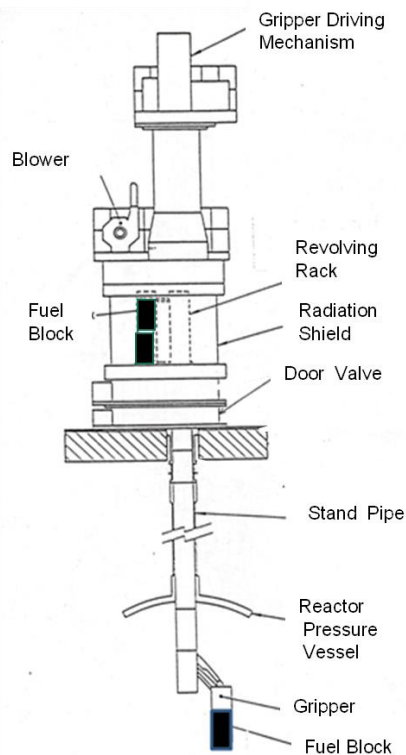

Figure 12: Door valve and refueling machine [27].

When the refueling machine is moved from the upper part of the reactor, the coolant (helium) in the reactor should not be allowed to leak. A door valve is provided between the refueling machine and the standpipe to prevent leakage of the coolant (helium) in the reactor to outside. The position of door valve is shown in Figure 12 [27]. Neutron detectors and gamma ray detectors are attached to the door valve, since the door valve is necessary to move out core components (anything such as spent fuel blocks, replaceable side reflectors and irradiated experimental material from the reactor).

3.2.3. Reactor core

The core consists of hexagonal columns of fuel blocks, control rod guide blocks and surrounding replaceable side reflector, constituted of blocks. The permanent reflectors surround the replaceable side reflectors. Fuel blocks are stacked vertically in several stages, and replaceable reflectors are placed above and below them. In order to accommodate the decrease in reactivity associated with fuel depletion as the reactor is operated, by design the reactor core is loaded with adequate excess reactivity at the beginning of operation. Each fuel block is engraved with a unique ID and loaded to a predetermined position in the reactor core. After a certain period of operation, the spent fuel block is taken out through the stand pipe using the refueling machine. The coolant flows through the flow paths in the graphite blocks and is heated. The heated coolant is brought into a hot plenum and guided to outside of the reactor pressure vessel at a temperature of 700 to 950 °C.

The control rods are suspended from the control rod drive mechanism in standpipes above the core and inserted into the core or reflector, as needed. Control rod guide columns for inserting control rods are provided in the core.

Any undeclared movement of the refueling machine would be detected by surveillance cameras. Furthermore, irradiation of undeclared material is detectable with the neutron and gamma ray detectors attached in the door valve used for introducing and removing materials into and from the core. The combination of neutron and gamma ray detectors, shown in Figure

13 [26] makes it possible to distinguish the nature of materials introduced into the core or removed from it as nuclear materials and non-nuclear materials. Data obtained by both detectors should be continuously transferred to safeguards inspectorates to avoid Cyber-attacks or other tampering.

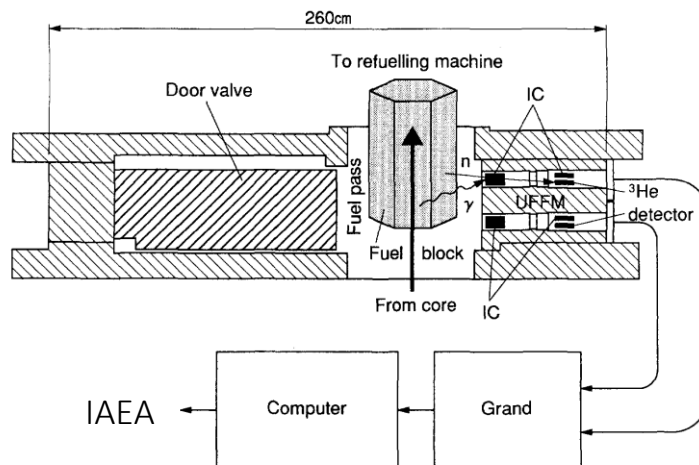

Figure 13: Neutron detectors and gamma ray detectors installed in the door valve for B-VHTR [26].

3.2.4. On-site spent fuel storage

The spent fuel blocks are stored for a certain period in racks of the spent fuel storage facility that includes a water-cooling system in order to remove decay heat. The movement of spent fuel blocks can be detected by an adequate C/S system such as sealing the lid on the top of the storage racks and monitoring them with further surveillance cameras.

3.2.5. On-site radioactive waste storage

Substances that do not contain nuclear fuel materials, such as activation products, are stored in the on-site radioactive waste storage facility, so their attractiveness from the PR viewpoint is low. However, such materials should be protected from a PP viewpoint.

3.2.6. Spent fuel shipping

The spent fuel blocks in storage are put in fuel transfer casks for shipping to the final disposal or to the reprocessing plant after cooling for a certain period in the spent fuel storage on site. Continuity of Knowledge (CoK) is maintained by use of adequate C/S systems, such as sealing transfer casks, and adequate PP is also applied, such as protection by guards. The spent fuel blocks are not attractive as sources of explosive nuclear materials used for NED due to the poor quality of the materials and the great difficulty of reprocessing. But they may be attractive from the view point of "radiological sabotage" due to their high radioactivity content.

3.3. System elements related to reactor site of P-VHTR

For safeguards purposes, P-VHTR is regarded as a quasi-bulk type facility. In the past, however, there have been cases where safeguards were implemented by assigning IDs to pebbles at the research reactor level, but not for online monitoring during the re-loading procedure. However, it is usually sufficient for safeguards to just count/keep track of the

number of fresh fuel and spent fuel pebbles as they are moved from and to their respective storage systems. The operating temperatures and high pressure of the system would make it difficult to divert fuel out of the core.

3.3.1. Fresh fuel storage on site

The containers with fuel pebbles are stored in the fresh fuel storage under an adequate C/S system and PP for P-VHTR. These fuel pebbles are moved to the charging room to be loaded into the reactor core. The number of fuel pebbles should be counted if it is possible, and the movement of the fuel pebbles from the fresh fuel storage to the charging room should be observed via surveillance cameras. Diversion or otherwise acquisition of fuel pebbles is not attractive due to the difficulty of recovering the nuclear material from fuel elements and because the amount of nuclear material in them is small.

3.3.2. Recirculation of irradiated fuel pebbles

The fuel pebbles have no identification numbers and are loaded randomly into the reactor core. The amount of nuclear material in every fresh fuel pebble is the same (heavy metal loading and uranium enrichment level). If initially fueled entirely with fresh fuel pebbles, P-VHTR cores would become critical with a small total volume of fuel. Therefore, graphite balls and boron balls containing no fuel are loaded into the core along with the fresh fuel in order to maintain the desired height of fuel in the core. With fuel depletion, graphite balls and boron balls are removed, and fresh fuel pebbles are loaded in, as the core evolves from the initial loading core to the equilibrium core. Figure 14 shows the movement of the fuel pebbles in the reactor [28]. Fuel pebbles are taken out from the core through the fuel pebble discharging tube. Failed fuel pebbles are separated and are stored in the scrap containers. Sound fuel pebbles are led to the dosing wheel where their fuel burnup levels are measured. The fuel burnup is evaluated by measuring the Cesium-137 gamma ray peak with a gamma spectrometer. However, it has recently been suggested that Cs-137 would not necessarily be a good burnup indicator, and Zr-95, Nb-95, and La-140 may provide more appropriate burnup instead [29]. Further research is needed. The fuel pebbles that have achieved a predetermined burnup level are discharged through the discharge tube and are led to containers in the discharge compartment as spent fuel pebbles. On the other hand, fuel pebbles that have not reached the predetermined burnup level are transported pneumatically to the upper part of the core and reloaded at the top of the core. This reloading is repeated until the fuel pebble reaches the predetermined burnup level. The number of reloading cycles is typically between 5 to 15. The precise figure depends on the specific design, reloading pattern and target burnup levels. High fuel burnup is achievable due

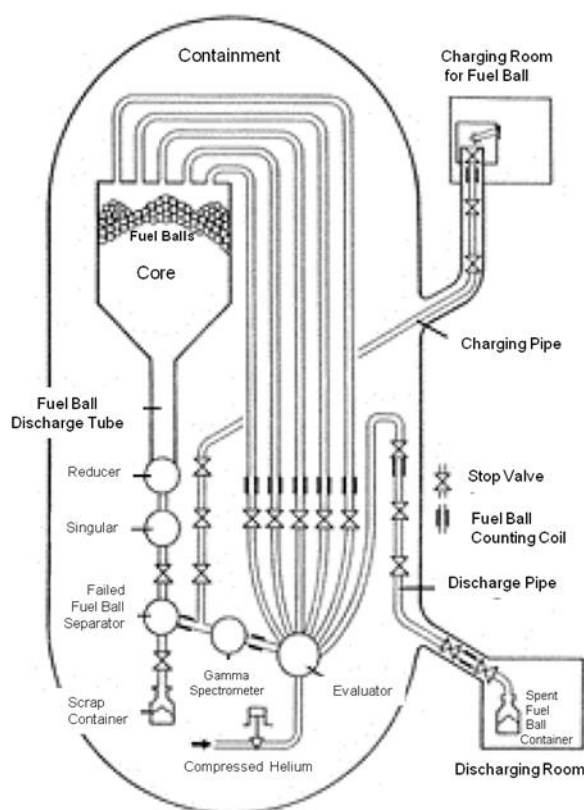

Figure 14: Movement of the fuel pebbles for P-VHTR [15,28].

to the highly stable characteristics of coated fuel particles and due to nearly continuous fuel loading. It is higher than the burnup of LWRs as well as that of B-VHTR. A burnup level of 100 GWd/T is achievable for the spent fuel of P-VHTR, and it results in superior proliferation resistance features due to large isotopic fraction of high content in plutonium that produces a high level of decay heat. The physical inventory verification in the reactor core is performed by controlling the number of fresh fuel pebbles loaded and accounting for the spent fuel pebbles discharged and the number of failed fuel pebbles discharged to the scrap container. Access to the reactor cell will be controlled by an adequate C/S system and PP.

3.3.3. *On-site spent fuel storage*

The spent fuel pebbles in containers are stored for a certain period in the on-site spent fuel storage. The containers are cooled in order to remove decay heat. The movement of a container can be observed using an adequate C/S system, such as sealing the containers and monitoring the storage area with surveillance cameras. The amount of fissile nuclear material (U-235 and Pu-239) in the spent fuel pebbles is small due to high burnup and high content of decay heat-generating Pu isotopes. One interesting discussion is the treatment of damaged pebbles. Depending on a particular design, the damaged pebbles are either added to the spent fuel storage (i.e. there is no separate waste storage of broken pebbles) or separated and stored for more permanent disposal [16]. However, since damaged pebbles are less burnt, they are potentially more attractive in terms of Pu quality.

3.3.4. *On-site radioactive waste storage*

Substances that do not contain nuclear fuel materials, such as activation products, are stored here, so their attractiveness from the PR viewpoint is low. However, these waste materials still need to be protected from a PP viewpoint.

3.3.5. *Spent fuel shipping*

The spent fuel pebbles in containers will be transferred to the final disposal or to the reprocessing plant after cooling for a certain period in the spent fuel storage area on site. COK is ensured using an adequate C/S system such as sealing the containers and monitoring the movement of the containers with surveillance cameras. The spent fuel pebbles are not attractive from the point of view of nuclear materials for use for NEDs, but they may be attractive from the view point of "radiological sabotage" due to their high radioactivity content. See the section 5.2 for more discussion.

3.4. System elements related to reprocessing site or final disposal site of spent fuel for B-VHTR and P-VHTR

The treatment of spent fuel of both B-VHTR and P-VHTR can be divided into (1) direct final disposal and (2) reprocessing. The direct disposal option is preferable because the coatings of coated fuel particles themselves are "containers" for the fission products and the fuel itself possesses high mechanical and chemical stability. Thus, the direct final disposal of the VHTR fuel has reduced environmental and public impact.

The reprocessing of VHTR fuel is considered challenging. The reason is that metric tons and tens of cubic meter quantities of carbon encasing coated fuel particles would have to be removed using either grind-leach, burn-leach or electrolysis in nitric acid if reprocessing were to be performed. However, these technologies have still not been demonstrated at industrial level. For this reason, spent fuel of VHTR has low attractiveness for diversion / acquisition and / or processing as nuclear material. Spent fuels from the VHTR may potentially still be attractive for radiological sabotage due to their high content in radioactive materials that results from their high fuel burnup levels. The physical robustness of VHTR fuel is favorable in this respect,

making it more difficult for a potential adversary to achieve widespread dispersal. The proliferation resistance features corresponding to the reprocessing of the spent fuel of VHTR mentioned-above are valid not only for spent fuels of LEU-fuel, but also for that of LEU / Th, LEU/Pu (MOX), Pu / Th MOX with high burnup.

3.5. Diversion targets

The key proliferation resistance feature of the VHTR is the fuel itself. The extraction of a significant quantity (SQ) of either indirect-use U-235 from LEU (75 kg) or direct-use U-233 and plutonium (both 8kg) from VHTR fuel will require the processing of metric tons and tens of cubic meter quantities of carbon encasing coated particles using either grind-leach, burn-leach, or electrolysis in nitric acid. A background report [14] that supported the compilation of the original PR&PP VHTR white paper (published in 2011) [2] discussed diversion targets for the two fuel forms, prismatic block and pebble. The following discussion is quoted from the background report [14] with some modifications using the PBMR [16] and the GT-MHR [6-8] as example plants for the P-VHTR and the B-VHTR respectively.

“Using the PBMR as an example, the diversion of an indirect-use significant quantity (75 kilograms) of U-235 in LEU in fresh pebbles would require, for the equilibrium core with a pebble loading of 9 grams of LEU at 9.6% enrichment, $75,000/(9 * 0.096) = 86,806$ pebbles or ~17.4 MT of fuel pebbles, which should be quite readily detectable even over time since that is ~20 percent of a core loading.” “By comparison, for the prismatic core GT-MHR or MHTGR using fuel elements with inscribed serial numbers for visual tracking, the diversion of an indirect-use significant quantity (75 kilograms) of U-235 in LEU in fuel elements containing ~3.43 kilograms of LEU on average at 19.8% enriched would require $75/(3.43 * 0.198) = \sim 111$ fuel elements or 13.5 MT of fuel elements, which would be ~15–16% of a GT-MHR core loading or ~17% of the MHTGR core loading.” “Thus, the mass ratio for the diversion of indirect-use U-235 in LEU between fresh pebbles and fresh GT-MHR fuel elements is $17.4/13.5 = \sim 1.29$ so that 29% more pebbles by mass would have to be diverted to obtain 75 kilograms of indirect-use U-235 in LEU.”

“Because the fuel elements of PBMRs are quite difficult to track, the use of LEU-fueled PBMRs has been examined by several researchers from the aspect of the attractiveness for diversion of fully burned spent fuel, one-cycle-irradiated pebbles, and the use of special production pebble.”

“The calculation results for the plutonium isotopic fractions in the PBMR fully burned spent fuel would likely be very close to those for the prismatic VHTR spent fuel where the prismatic fuel is to be discharged at a burn-up exceeding 100 GWD/MT (or MWD/kg). The PBMR and prismatic VHTR spent fuel will have slightly different plutonium isotopic compositions resulting from differences in the thermal-neutron and epithermal-neutron energy spectra due to a different moderator-to-fissile atom ratio and additional thermal and epithermal neutron self-shielding due to the higher-density fuel compacting used in the prismatic fuel.” It is expected, however, that the spent LEU fuel from both the GA GT-MHR and Areva Modular HTR will have plutonium isotopic fractions very close to the values calculated for the PBMR in Table 3.6.1.” Table 3.6.1 [14] is reproduced hereafter as table 1. It appears that the Pu will be of reactor grade, and deep-burn in the case of highest enrichment and burnup, by applying the fissile material type metric of PRPPWG³.

³ The GIF PR&PP Evaluation Methodology categorizes the nuclear material inside a given target “based on the degree to which its characteristics affect its utility for use in nuclear explosives”. Its example metrics defines WG-Pu as “weapons-grade plutonium, nominally 94% fissile Pu isotopes”, RG-Pu as “reactor-grade plutonium, nominally 70% fissile Pu isotopes”, DP-Pu as “deep burn plutonium, nominally 43% fissile Pu isotopes” [1].

% Enrichment (U-235)	Average Discharge Burnup (MWd/kg)	Pu Isotopic Fractions				
		Pu-238	Pu-239	Pu-240	Pu-241	Pu-242
7%	70	1%	46%	29%	15%	9%
8%	80	1%	46%	28%	16%	9%
10%	100	1%	46%	26%	17%	11%
15%	150	2%	44%	23%	18%	13%
20%	200	4%	42%	20%	19%	15%

Table 1: Calculated plutonium isotopic fractions for PBMR spent fuel as a function of initial enrichment and discharge burn-up [Table 4.1 from [14]].

“Because the PBMR recirculates a pebble up to six times through the core before it is discharged to spent fuel storage at full burn-up (~92 GWD/MT), the question arises about the diversion of an irradiated pebble after one cycle or the use of special pebbles designed as target elements to produce plutonium.” “The analysis of the PBMR by PBMR (Pty) Ltd. [16] shows in Figure 15 [14] the plutonium build-up per pebble and the relative isotopic content as a function of recirculation.”

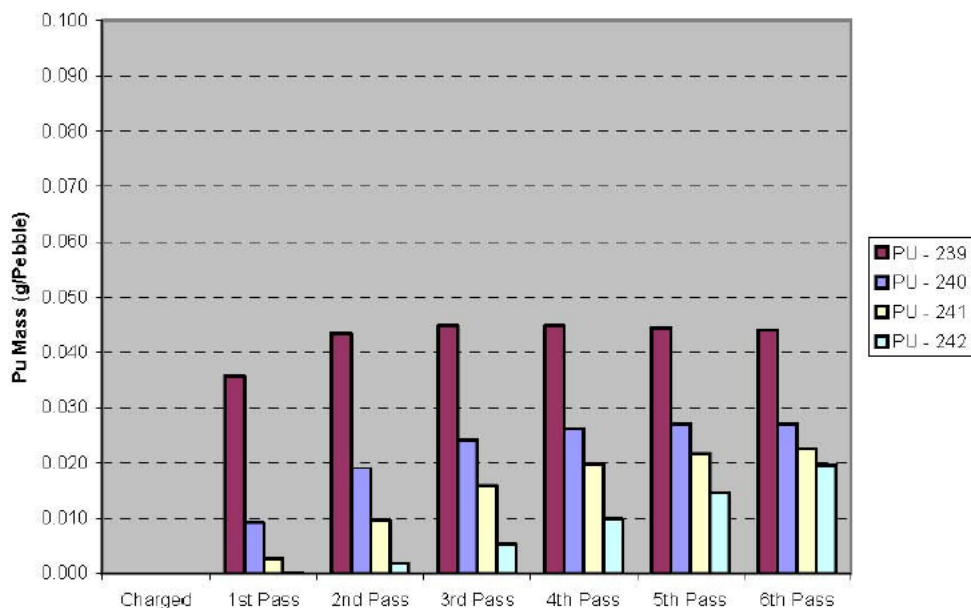

Figure 15: Plutonium build-up in a PBMR fuel element in an equilibrium core [14].

“Figure 15 indicates that at full burn-up each pebble will contain about 0.11 grams of plutonium with the isotopics indicated, and, from this, it can be inferred that, at full burn-up (120 GWD/MT in the GT-MHR), the prismatic fuel elements can be estimated to contain on the order of 60–70 grams of plutonium of similarly degraded isotopics.” The diversion of 1 SQ of direct-use Pu from pebbles at full burn-up requires $8,000/0.11 = 72,727$ pebbles or ~14.4 MT of fuel pebbles. It takes $8,000/65 = 123$ prismatic fuel elements to secure 1 SQ of direct-use Pu.

“However, the LEU pebble in a PBMR is recirculated up to six times while the fuel element in a GT-MHR or MHTGR is typically reloaded only once. From Figure 15, the plutonium content of a pebble after its initial irradiation is given as ~0.047 grams (~74% Pu-239), whereas for the GT-MHR there are no data quoted for the one-cycle-burned prism, but it is inferred that the plutonium loading would be ~50 grams with less favorable isotopics than in the pebble after

one cycle of irradiation. From this, a rough comparison can be made that it would take at least ~1050 pebbles diverted after the first cycle to equal the amount of less favorable plutonium in a prismatic fuel element removed from a GT-MHR after the first irradiation.” Table 2 shows a summary table indicating the amount of material needed to collect an SQ.

Similar considerations can be derived from other designs.

Diversion Target	U-235 from Fresh LEU	Pu from Spent fuel
SQ	75 kg	8kg
Equivalent pebbles	86806 (17.4 MT)	72727 (14.4 MT)
Equivalent blocks	111 (13.5 MT)	123 (15.0 MT)

Table 2: Summary of data for PBMR and GT-MHR from [14].

4. Proliferation Resistance Considerations Incorporated into Design

The fuel in reactor cores of B-VHTR and P-VHTR is not as accessible and visible as the fuel in an LWR. Therefore, physical inventory verification of nuclear materials in the reactor cores is carried out by measurement of fuel flows into and from the core. Major Material Balance Areas and Key Measurement Points are shown in Figure 16 as an example. Also, adequate C/S is necessary. Adequate counter-measures against cyberattacks are required to maintain CoK by C/S.

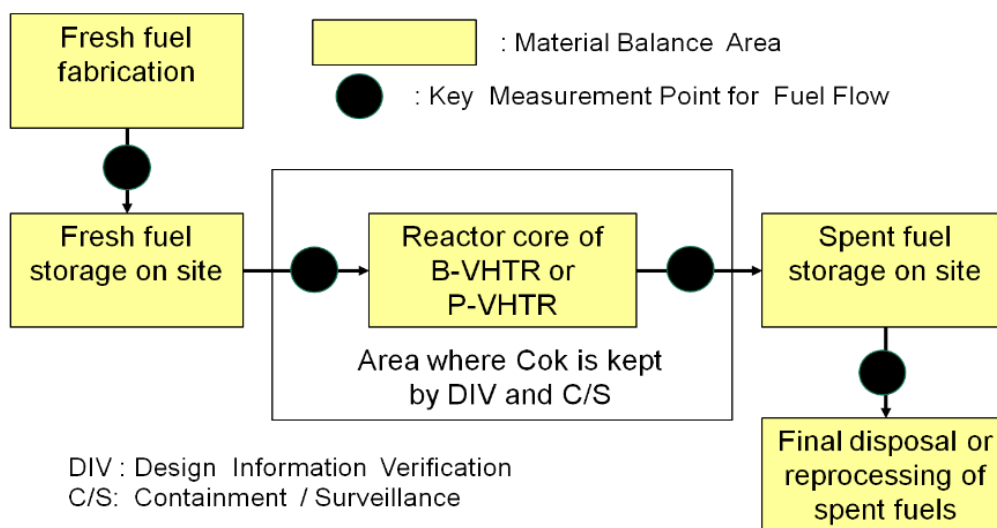

Figure 16: Material Balance Areas and Key Measurement Points of B-VHTR and P-VHTR.

Design Information Verification (DIV) and C/S are implemented to avoid concealment of fuel. Direct transfer of the C/S signal to IAEA is recommended to enhance proliferation resistance.

As noted previously, the key proliferation resistance feature of the VHTR is the fuel itself. To obtain a significant quantity of either indirect-use U-235 from LEU or direct-use plutonium, one must process metric tons and tens of cubic meter quantities of carbon encasing fuel using either grind-leach or burn-leach or electrolysis in nitric acid.

The high burnup of the spent fuel of the VHTRs is also a key proliferation resistance feature due to the high isotopic fraction of even plutonium isotopes generating large amounts of decay heat and high dose rate. However, it is controversial.

Historically, it has been argued that the technical difficulty of fabricating nuclear weapons depends on the isotopic composition of plutonium, in particular the amount of Pu-240. Although there are several references, the one that summarizes the key points is by Pellaud [30].

For nuclear safeguards verification activities there is no distinction for Pu with less than 80% Pu-238. However, the heat generated by Pu isotopic containing more than a few percent of Pu-238 would substantially increase the technical difficulty related to the fabrication phase (weaponization). Using a set of figures of merit (FOM) for attractiveness, Bathke, et al. [31] estimated that about 8% Pu-238 is required to render the plutonium isotopic unattractive for an unadvanced proliferant state that requires reliably high-yield nuclear devices, however it remains attractive for both technologically advanced states, which can handle it, and subnational groups for which high reliability might not be a requirement. However, these arguments are founded on the assumption that the proliferants demand reliable yield. In the case of unadvanced proliferant or non-state actors who do not pay attention to the yield, high reliability might not be their requirement.

With those reasons considered, the current GIF PRPP WG methodology suggest a

categorization in: weapon grade, reactor grade, and deep-burn grade for Pu [1]. The fact that Pu in HTGRs' spent fuel can achieve deep-burn is one of the notable features.

4.1. Concealed diversion or production of material

Diversion of large quantities of nuclear materials (U-235, plutonium or U-233) is detectable by spent fuel accountancy based on radiation monitoring or fuel element counting, by C/S on fuel storage, or by recorded reactivity deviations in reactor operations. The VHTR does not produce readily accessible, attractive fissile material. The technologies for reprocessing coated fuel particles are complicated and still require development.

4.1.1. Diversion of unirradiated nuclear material items

Once the fuel has been encased within fuel kernel of coated fuel particle and furthermore into fuel elements (such as fuel compacts for B-VHTR or fuel pebbles for P-VHTR), diversion becomes difficult. The latter (fuel elements) consist of coated fuel particles encased within graphitized carbon. Note that fresh fuel fabrication should be performed under surveillance. Once in fuel assembly (compact ball) form, the nuclear material is more difficult to retrieve due to difficulty of separation of nuclear material from large amounts of graphite and of the strength of the coatings of particles. Fabricated fresh fuel can be stored under C/S measures for B-VHTR and P-VHTR. The diversion during transportation of fresh fuel can be detected by the C/S. The raw constituents are observed under the same C/S applied for fuel fabrication of LWR.

4.1.2. Diversion of irradiated nuclear material items

4.1.2.1. B-VHTR

The major irradiated nuclear material items are spent fuel blocks. Diversion of Pu is possible by discharging fuel blocks after a short time of reactor operation and then reprocessing them. The fuel blocks are unloaded through standpipes over the reactor pressure vessel. For such an operation, both the refueling machine and the door valve are required because it is necessary to maintain isolation between the reactor coolant and the outside atmosphere for the B-VHTR. Unexplained or illicit movements of the refueling machine and the door valve by the crane can be detected by surveillance cameras. Also, undeclared movements of prematurely discharged fuel blocks are detected by the neutron detector and the gamma ray detector in the door valve. Any discharged material from the reactor pressure vessel can be identified as nuclear material or not. Nuclear material is indicated when signals of both neutron and gamma ray are detected. If the material is non-nuclear, such as a surveillance sample, then no neutron source is detected. Undeclared discharging of experimental nuclear materials is detected in the same manner as fuel blocks.

4.1.2.2. P-VHTR

Diversion of Pu may be possible using the continuous fuel loading feature through early discharging of fuel pebbles from the reactor core before even-mass-number Pu isotopes are accumulated. However, this would be detected by the burnup measuring detectors. Furthermore, it is technically difficult because the reprocessing process of VHTR fuel is still not established and detection of this diversion route is possible if an appropriate C/S system is in place.

4.1.3. Undeclared production of nuclear material

4.1.3.1. B-VHTR

Undeclared production of nuclear material may be possible through the irradiation of fertile nuclear material in irradiation holes in the core or replaceable side reflectors of B-VHTR. The materials would be loaded and unloaded through standpipes over the reactor pressure vessel. In the B-VHTR, it is not possible to directly access and to visually observe the fuel in the core or the replaceable side reflectors as would be possible in LWRs where water above the core is used as radiation shielding. For these reasons, a handling machine with radiation integrated shielding function, such as the refueling machine, is necessary for any undeclared production of nuclear material. Any unexplained or illicit movement of handling machines can be detected by surveillance cameras in the reactor building. Moreover, ton quantities of fertile material would need to be loaded illicitly to generate a SQ, and it is difficult to envisage this being practical to achieve without detection.

It should be noted that B-VHTR could be used in a mode similar to that of the Magnox reactors for producing weapon-grade plutonium. In this case, rod-type Magnox fuel containing metal uranium would be inserted into some cooling holes of the graphite blocks instead of using ordinary B-VHTR fuel rods based on coated particle fuel. In this way the difficulty of reprocessing of VHTR fuel would be avoided, as the reprocessing methods for Magnox fuel are well established. However, the reactors would have to be operated with low reactor coolant outlet temperatures to protect the integrity of the Magnox fuel and ton quantities of Magnox-type fuel would need to be irradiated. This would imply giving up efficient power production, which would be detectable. It might be worth thinking that this mode of operation could be dangerous because of accumulation of Wigner energy in the graphite blocks, but further study is needed.

4.1.3.2. P-VHTR

The inlet pipes of fresh fuel pebbles, in the fuel charging room, can be used for loading target pebbles and for the access to the core region of a P-VHTR. However, these pipes cannot be easily used for loading illicit material for the undeclared production of nuclear materials due to the length of, and many curves in, the fuel loading path. Pebbles with diameter of 6 cm could be loaded into the pipe. It is very important to confirm in Design Information Verification that there are no access holes into the pipes except at the fresh fuel pebble loading location, precluding any other pipe access into the reactor core. Irradiation of fertile materials covered with graphite or carbon that look like fuel pebbles is possible. But such pseudo-fuel spheres may break during movement through the core and would be difficult to remove. Furthermore, such pseudo-fuel without ceramic coatings would release unexpected high radioactivity into the primary cooling system at high temperature operation, which would be detectable. In addition, there would result many operational problems, which would also be detectable and require explanation. In addition to that, ton quantities of such pseudo-fuel spheres containing fertile materials need to be irradiated to obtain a SQ of fissile material. Finally, it is important to recognize that the presence of target breeding pebbles in the core will alter the balance between fresh fuel demand and energy production in a way that is detectable long before a SQ of fissile material is accumulated [32-35].

4.2. Breakout

As mentioned in section 3.4, reprocessing has not yet been demonstrated for the coated fuel particles at industrial scale. In the presence of multi-lateral contractual provisions, for example adhering to the guidance of the international Nuclear Suppliers Group (NSG), for the supply of fresh fuels and the take-back of spent fuels for an exported VHTR, the issue of breakout is further mitigated since there will be either no such material, or limited quantities of material, to be reprocessed in the host states.

4.2.1. Diversion of existing nuclear material

As mentioned in Section 3.4, the key proliferation resistance feature is the use of coated fuel particles embedded within a graphite matrix. Therefore, diverting existing nuclear material from VHTR fuels is difficult, lengthy and costly, regardless of the implementation of safeguards and PP for the fuels. Since the reprocessing technology is not developed to industrial level, extraction of nuclear material is significantly difficult. Moreover, the high burnup of spent fuel from VHTRs is also a key proliferation resistance feature due to the presence of plutonium isotopes that produce large amounts of decay heat. Pu in high burnup spent fuel contains considerable even-numbered Pu isotopes, i.e. Pu-238, 240 and 242, whose decay heat negatively affects use as a NED. Note that the diversion of raw material before being coated with carbon and silicon carbide would be the easiest pathway for the processing of nuclear materials to be used in the fabrication of nuclear explosive devices. However, this is not a VHTR-specific problem, but a concern for all types of nuclear reactor systems.

4.2.2. Production of weapons usable nuclear material

As mentioned in section 3.4, the key proliferation resistance feature of VHTRs is the use of coated fuel particles embedded within graphite matrix. It is necessary to process metric tons and tens of cubic meter quantities of carbon encasing the fuel kernels to obtain the amount of nuclear material necessary for production of weapons.

4.3. Pu Production in clandestine facilities

High quality graphite with very low impurity levels is used in the technology of the B-VHTR and P-VHTR. This high quality graphite can be used for gas-cooled reactors in which weapons-grade plutonium can be produced from natural uranium. Therefore, the consumption of large amounts of nuclear-grade graphite should be controlled. For that reason, nuclear grade graphite is controlled according to NSG lists part 1 for trigger list equipment [36].

Operation of the clandestine facilities (reactor and fuel reprocessing) could be detected by environmental sampling under the international safeguards regimes.

5. Physical Protection Considerations Incorporated into Design

This section provides a qualitative overview discussion of the aspects of VHTR systems and their design that create potential benefits or problems from the point of view of potential threat by sub-national actors.

5.1. Theft of material for nuclear explosives

Plutonium in the spent fuel of LEU cycles and U-233 in that of future LEU/Th cycles are attractive for the NED production. However, these nuclear materials in spent fuels are accompanied with fission products, which are highly radioactive and make it difficult for terrorists to steal the materials. Moreover, the nuclear materials are encased inside the coated fuel particles. In these coated particles, the material of interest would be quite diluted so that the theft of a significant quantity would require the theft of metric tons of contaminated graphite and/or graphitized carbon containing the coated fuel particles. Obtaining access to a significant quantity of plutonium or U-233 in the stolen spent fuels would require substantial effort for reprocessing. Furthermore, plutonium with a high inventory of the plutonium isotopes other than Pu-239 is not attractive for the manufacturing of NEDs (e.g. high decay heat). U-233 with hundreds of parts per millions of U-232 is not attractive due to high radioactivity and to the necessity of further chemical cleaning to remove radioactive decay products. For those reasons, the intrinsic qualities of VHTR spent fuel make it undesirable as a target for theft by a sub-national group for use as nuclear explosive.

5.2. Radiological sabotage

VHTRs are designed such that the fuel temperature is maintained below fuel-damaging temperatures under all conditions of normal operations and accident situations, including beyond-design-basis events. The design vision is that, even if the safety-related reactor cavity cooling system were to malfunction, decay heat in the core would still be removed to the external wall of the reactor vessel. As a result, the fuel temperatures in the core do not exceed the levels that would cause the loss of the primary containment provided by the SiC coatings over the fuel kernels.

The ultimate radiological sabotage act for reactors is that of an insider or an intruder trying to cause radiological exposure by inducing a large power excursion. For both P-VHTR and B-VHTR designs, appropriate physical protection and controls must be in place to prevent such acts. These designs have several safety benefits from the very high temperature tolerance of the fuel and the strong negative temperature power coefficient.

Another relevant discussion is that both VHTRs are extremely resilient to this kind of terrorist attacks because passive heat removal, or reactor cavity cooling system (RCCS), by air cooling, water or a combination of both is available when a loss of coolant happens.

The high burnup levels in the spent fuel of both VHTR types is one of the key proliferation resistance features due to high radioactivity. However, spent fuels of VHTRs may be attractive for Radiological Dispersion Device (RDD) due to high radioactivity resulting from the high burnup. Below is a short the discussion of RDD for both P-VHTR and B-VHTR:

- In the case of P-VHTR, the quasi-bulk fuel form may be attractive for terrorists when considering the possibility of dispersal of the spent fuel. Protection of spent fuel on the reactor site will be important. This should also be considered in PP when transporting spent fuel by land.
- In the case of B-VHTR, the item-type fuel allows its PP to be similar to that of LWRs. Moreover, TRISO has high-melting point and is considered to be very resistant to FP release.

Finally, some points to be considered for the PP of VHTR are listed referring to the previous VHTR white paper:

- Quality controls at the fuel fabrication plant in the supplier nation.
- Proper maintenance, inspection, and protection of (1) the helium supply and the helium supply station to prevent the introduction of corrosive chemicals, (2) the primary coolant contaminant monitoring equipment to detect the introduction of such chemicals, and (3) the helium purification system to remove contaminants.
- Careful maintenance, inspections, testing and protection of reactivity control systems to assure the capability to achieve safe hot and cold shutdown and, if required, accomplish the same function from a secure remote location.
- Physical protection is required of and controlled access to fresh and spent fuel storage locations, the inbound and outbound transportation loading systems, the transportation of the fresh fuel from the fuel fabrication facility, and the spent fuel to its processing or disposal facilities.

6. PR&PP Issues, Concerns and Benefits

The key areas of known strengths of the VHTR concept at this time are its robust fuel form, with fissile material strongly diluted in carbonaceous material, high burnup and the use of the once-through LEU fuel cycle, which all make VHTR fuel unattractive for proliferation purposes.

When considering PR, different safeguards approaches are required; item-based safeguards will be applied for B-VHTR, while quasi-bulk-type safeguards will be required for P-VHTR.

Regarding PP, typical reactor site protections on the reactor, control systems, and fresh and spent fuel storage will be required. It can be concluded that VHTRs are extremely resilient to terrorist attacks because RCCS is available when a loss of coolant happens.

System designers, program policy makers, and external stakeholders who read this white paper are encouraged to evaluate PR&PP features using the GIF PRPP WG methodology from an early stage of design, and keep updating them as designs progress.

A summary of the main PR relevant intrinsic design features of some designs is presented in Appendix 1 according to the IAEA document Proliferation Resistance Fundamentals for Future Nuclear Energy Systems [3].

7. References

- [1] PRPP Working Group of the Generation IV International Forum, "Evaluation Methodology for Proliferation Resistance and Physical Protection of Generation IV Nuclear Energy Systems", GIF/PRPPWG/2006/005, Revision 6, September, 2011.
- [2] PRPP Working Group and System Steering Committees of the Generation IV International Forum. "Proliferation Resistance and Physical Protection of the Six Generation IV Energy Systems", technical Report GIF/PRPPWG/2011/002, Generation IV International Forum (GIF), 2011.
- [3] IAEA, "Proliferation Resistance Fundamentals for Future Nuclear Energy Systems", IAEA STR-332, IAEA Department of Safeguards, IAEA, Vienna, 2002.
- [4] Gen IV International Forum, "GIF R&D Outlook for Generation IV Nuclear Energy Systems: 2018 Update," 2019.
- [5] M.A. Fütterer et al., "The High Temperature Gas-Cooled Reactor," Encyclopedia of Nuclear Energy, Elsevier, pp. 512-522, 2021, <https://doi.org/10.1016/B978-0-12-409548-9.12205-5>
- [6] M.B. Richards et al., Part 1 -- H2-MHR Pre-Conceptual Design Report: SI-Based Plant, GA-A25401, General Atomics, Idaho National Laboratory, and Texas A&M University, April 2006.
- [7] M.B. Richards et al., Part 2 -- H2-MHR Pre-Conceptual Design Report: HTE-Based Plant, GA-A25402, General Atomics, Idaho National Laboratory, and Texas A&M University, April 2006.
- [8] General Atomics, Gas-Turbine Modular Helium Reactor (GT-MHR) Conceptual Design Description Report, GA Document No. 910720, Revision 1, July 1996, transmitted by letter from Laurence L. Parme (GA) to Raji Tripathi (USNRC), "GT-MHR Conceptual Design Description Report," GA/NRC-337-02, General Atomics, San Diego, CA, August 6, 2002.
- [9] L. Lommers et al., "AREVA HTR Concept for Near-Term Deployment," Nuclear Engineering and Design, 251, pp. 292-296, October 2012. <https://doi.org/10.1016/j.nucengdes.2011.10.030>.
- [10] Brochure: ANTARES - The AREVA HTR-VHTR Design, <https://www.yumpu.com/en/document/read/32557580/antares-the-areva-htr-vhtr-design-smr>
- [11] V. Petrunin et al., "Analysis of questions concerning the nonproliferation of fissile materials for low-and medium-capacity nuclear power systems," Atomnaya Energiya 105, Issue 3, pp. 123-127, September 2008 (in English. pp. 159-164, Atomic Energy 105, Springer, New York, ISSN 1063-4258 (Print), 1573-8205 (Online)).
- [12] K. Kunitomi et al., "JAEA's VHTR for Hydrogen and Electricity Cogeneration: GTHTR300C," Nuclear Engineering and Technology 39, pp. 9-20, 2007.
- [13] J. Chang Keun et al., "Preconceptual Designs of the 200MWth Prism and Pebble-bed Type VHTR Cores," PHYSOR-2008, International Conference on the Physics of Reactors "Nuclear Power: A Sustainable Resource," Casino-Kursaal Conference Center, Interlaken, Switzerland, September 14-19, 2008.
- [14] D. Moses, "Very High-Temperature Reactor (VHTR) Proliferation Resistance and Physical Protection (PR&PP)," ORNL/TM-2010/163, Oak Ridge National Laboratory, 2010.
- [15] Presentations by PBMR (Pty) Ltd. to the U.S. Nuclear Regulatory Commission Public Meeting, PBMR Safety and Design Familiarization, February 28-March 3, 2006.
- [16] J. Slabber, PBMR (Pty) Ltd., "PBMR Nuclear Material Safeguards," Paper No. B14, Proceedings of the Conference on High Temperature Reactors, Beijing, China, September, 22-24, 2004.
- [17] E. Mulder et al., "The Coupled Neutronics and Thermo-Fluid Dynamics Design Characteristics of the Xe-100 200 MWth Reactor," Proceedings of the Conference on High Temperature Reactors, Las Vegas, Nevada, USA, November, 7-10, 2018.

- [18] Y. Dong, "China's activities in HTGRs HTR-10 and HTR-PM," In: IAEA Course on High Temperature Gas Cooled Reactor Technology. Beijing, China, 22-26 October 2012.
- [19] Z. Zhang et al., "The Shandong Shidao Bay 200 MWe High-Temperature Gas-Cooled Reactor Pebble-Bed Module (HTR-PM) Demonstration Power Plant: An Engineering and Technological Innovation," *Engineering* **2**, pp. 112-118, March 2016.
<http://dx.doi.org/10.1016/J.ENG.2016.01.020>
- [20] Y. Xu and K. Zuo, "Overview of the 10 MW high temperature gas cooled reactor—test module project," *Nuclear Engineering and Design* **218**, pp. 13–23, October 2002.
- [21] The image of XE-100 Reactor downloaded from:
<https://x-energy.com/media/xe-100>
- [22] M. A. Fütterer et al., "A High Voltage Head-End Process for Waste Minimization and Reprocessing of Coated Particle Fuel for High Temperature Reactors," Proc. ICAPP'10, paper 10219, San Diego, CA, USA, 13-17 June 2010.
- [23] GIF PRPPWG and SCWR SSC, "GIF Super Critical Water cooled Reactor Proliferation Resistance and Physical Protection White Paper", GIF/PRPPWG/2022/002, Generation-IV International Forum, April 2022.
- [24] Nuclear Fuel Industries, Ltd, "HTGR fuel manufacturing process 1. Fuel particle process," <https://www.nfi.co.jp/product/prod03.html> (accessed 2020-7-16).
- [25] K. Juergen et al., "Upgrading (V)HTR fuel elements for generation IV goals by SiC encapsulation," *Kerntechnik*, **77**(5), 351-355, 2012.
- [26] K. Yamashita et al., "Safeguards Concept for the High Temperature Engineering Test Reactor Using Unattended Fuel Flow Monitor System," *Journal of Nuclear Materials Management*, Volume XXV, Number 4, August 1997.
- [27] S. Saito et al., "Design of High Temperature Engineering Test Reactor (HTTR)," JAERI 1332, 1994, <https://doi.org/10.11484/jaeri-1332>.
- [28] U. Cleve et al., "The Technology of High-Temperature-Reactors," Proceedings of ICAPP 2011, Paper 11076, Nice, France, May 2-5, 2011.
- [29] T. Shiba et al., "Proliferation Resistance and Safeguardability of Very High Temperature Reactor," IAEA Symposium on International Safeguards , Vienna International Centre, Vienna (Austria), 5-8 November 2018.
- [30] B. Pellaud, "Proliferation Aspects of Plutonium Recycling," *Journal of Nuclear Material Management*, XXXI, 1, pp. 30-38, 2002.
- [31] C. Bathke et al., "The Attractiveness of Materials in Advanced Nuclear Fuel Cycles for Various Proliferation and Theft Scenarios," *Nuclear Technology*, Vol 179, Issue 1, 2012.
- [32] A.M. Ougouag and H. D. Gougar, "Preliminary Assessment of the Ease of Detection of Attempts at Dual Use of a Pebble-Bed Reactor," Transactions of the Winter 2001 Annual Meeting of ANS, Reno, NV, Trans. ANS 85, pp. 115-117, November 2001.
- [33] A.M. Ougouag et al., "Rational Basis for a Systematic Identification of Critical Components and Safeguard Measures for a Pebble-Bed Reactor" Transactions of the Winter 2002 Annual Meeting of ANS, Washington, DC, Trans. ANS 87, pp. 367-368, November 2002.
- [34] A.M. Ougouag et al., "Examination of the Potential for Diversion or Clandestine Dual Use of a Pebble-Bed Reactor to Produce Plutonium," Proceedings of HTR 2002, 1st International Topical Meeting on High temperature Reactor Technology (HTR), Petten, Netherlands, April 22-24, 2002.
- [35] A. M. Ougouag et al., "Evaluation of the Strategic Value of Fully Burnt PBMR Spent Fuel," Idaho National Laboratory, INL/EXT-06-11272, May 2006.
- [36] IAEA, "Communications Received from Certain Member States Regarding Guidelines for the Export of Nuclear Material, Equipment or Technology", INFCIRC/254 Part 1 and 2 (1978, updated

2019). <https://www.iaea.org/publications/documents/infcircs/communications-received-certain-member-states-regarding-guidelines-export-nuclear-material-equipment-or-technology>.

(This page has been intentionally left blank)

APPENDIX 1: VHTR Major Design Parameters

Appendix VHTR.A – VHTR Major Reactor Design Parameters

Major Reactor Parameters	General Atomics	Framatome	OKBM	JAEA	KAERI	X-Energy	Huaneng Group & CNEC/INET
	GT-MHR	SC-HTGR	GT-MHR	GTHTR300C	NHDD	Xe-100	HTR-PM
Thermal Power (MW-th)	600	625	600	600	200	200	250
Thermal Efficiency (%) in Electricity Generation	~48	~40	~48	~50	None, H ₂ production	40 (inferred)	40
Primary Coolant	Helium	Helium	Helium	Helium	Helium	Helium	Helium
Moderator	High-Temperature Graphite	High-Temperature Graphite	High-Temperature Graphite	High-Temperature Graphite	High-Temperature Graphite or Graphitized Carbon with Reflector	High-Temperature Graphitized Carbon with Graphite Reflector	High-Temperature Graphitized Carbon with Graphite Reflector
Power Density (MW/m ³)	6.3	~6.3 (inferred)	6.3	5.4	2.27-3.0 pebble, 5.68 prismatic	4.95 (max)	~3.22
Fuel Materials	UC _{0.5} O _{1.5} TRISO-coated particles; LEUC _{0.5} O _{1.5} (19.8%) fissile and U _{Nat} C _{0.5} O _{1.5} fertile	LEUO ₂ TRISO-coated particles	PuO _{1.8} , LEUCO or mixed uranium-plutonium oxide (MOX)	LEUO ₂ TRISO-coated particles	LEUO ₂ TRISO-coated particles	LEUO ₂ TRISO-coated particles	LEUO ₂ TRISO-coated particles

Appendix VHTR.A – VHTR Major Reactor Design Parameters (Continued)

Major Reactor Parameters	General Atomics	Framatome	OKBM	JAEA	KAERI	X-Energy	Huaneng Group & CNEC/INET
	GT-MHR	SC-HTGR	GT-MHR	GTHTR300C	NHDD	Xe-100	HTR-PM
Core Inlet Temperature/Pressure (°C/MPa)	490/7.07	325/6.0	490/7.07	587-666/6.9 (electrical production) & 594/5.1 (H ₂ production)	490/~7.0	260/~6.1	250/~7.0
Core Outlet Temperature/Pressure (°C/MPa)	850/7.0	750 for electricity generation)	850/7.0	850-950/6.9 (electrical production) & 950/5.1 (H ₂ production)	950/~7.0	750/~6.0	750/~7.0
Neutron Energy Spectrum	Thermal peaking just below 0.3 eV	Thermal peaking just below 0.3 eV	Thermal peaking just below 0.3 eV	Thermal peaking just below 0.3 eV	Thermal peaking just below 0.3 eV	Thermal peaking just below 0.3 eV	Thermal peaking just below 0.3 eV

Appendix VHTR.B – A Comparison of VHTR Fuel Cycle Parameters

Fuel Cycle Parameters	General Atomics	Framatome	OKBM	JAEA	KAERI	X-Energy	Huaneng Group & CNEC/INET
	GT-MHR	SC-HTGR	GT-MHR	GTHTR300C	NHDD	Xe-100	HTR-PM
Reactor Thermal Power (MW-th)	600	625	600	600	200	200	250
Reactor Electrical Power (MWe) Generation	262 to 286 (varied assumptions documented)	~250, 186 for cogeneration with process heat use	262 to 286 (varied assumptions documented)	274-302 depending on outlet T, 87- 202 depending on H ₂ production	Only H ₂ production	80 (inferred)	100 per reactor in two reactors per module
Fuel type	LEU	LEU	Pu initially	LEU	LEU	LEU	LEU
-Form	Ceramic coated particle	Ceramic coated particle	Ceramic coated particle	Ceramic coated particle	Ceramic coated particle	Ceramic coated particle	Ceramic coated particle
-Fertile material	U-238	U-238	None	U-238	U-238	U-238	U-238
-Fissile material	U-235	U-235	Pu	U-235	U-235	U-235	U-235
Enrichment (%)	19.8 in fissile particles, 0.7 (U _{Nat}) in fertile particles	~15	Pure Pu	~14	9.6 pebble, 15.5 prismatic	10	8.5 in the equilibrium core

Appendix VHTR.B – A Comparison of VHTR Fuel Cycle Parameters (Continued)

Fuel Cycle Parameters	General Atomics	Framatome	OKBM	JAEA	KAERI	X-Energy	Huaneng Group & CNEC/INET
	GT-MHR	SC-HTGR	GT-MHR	GTHTR300C	NHDD	Xe-100	HTR-PM
Source of Fissile Material (inputs are assumed since not given in available documentation)	U.S. or European enrichment plants (inferred)	U.S. or European enrichment plants (inferred)	Russian excess weapons Pu; other U and Pu in later versions	Undefined	Undefined	U.S. or European enrichment plants (inferred)	Undefined
Fuel Inventory (MT)	4.68 initial core, 2.26 each reload	Not given	~1.8 in equilibrium cycle	Not given	Not given	~2.0 in equilibrium core	~2.9 in equilibrium core
Discharge Burn-up (GWD/MT)	121 for LEU cycle	150	~120-150	120	153	175	90
Refueling frequency (months)	18	18	18	24/18 (electrical)/18 (H ₂)	Pebble continuous;	Continuous on line	Continuous on line
Recycle Approach	Baseline is once-through	Baseline is once-through	No recycle, deep-burn	Baseline is recycling	Baseline is once-through	Baseline is once-through	Baseline is once-through
Recycle Technology	To be developed	To be developed	No recycle, - deep-burn	To be developed	To be developed	To be developed	To be developed
Recycle efficiency	To be determined	To be determined	No recycle, deep-burn	To be determined	To be determined	To be determined	To be determined

APPENDIX 2: Summary of PR relevant intrinsic design features. Reference IAEA-STR-332. Please refer to IAEA-STR-332, for full explanations and complete definitions of terms and concepts [3].

Summary of PR relevant Intrinsic design features	B-VHTR (General Atomics' GT-MHR, SC-HTGR, OKBM's GT-MHR, GTHTR300C, NHDD)	P-VHTR (Xe-100, HTR-PM)
Features reducing the attractiveness of the technology for nuclear weapons programmes		
1. The Reactor Technology needs an enrichment Fuel Cycle phase	Yes	Yes
2. The Reactor Technology produces SF with low % of fissile plutonium	Higher burnup than LWR SF resulting in low % fissile plutonium.	Fully burn pebbles have higher burnup than LWR SF resulting in low % fissile plutonium.
3. Fissile material recycling performed without full separation from fission products	No recycling	No recycling
Features preventing or inhibiting diversion of nuclear material		
4. Fuel assemblies are large & difficult to dismantle	Yes. Fuel pellets are inserted in holes in fuel blocks.	There is no fuel assembly in P-VHTR. Fuel pebbles are small but to acquire 1 SQ of U-235 or Pu would require a large number of pebbles (tens of thousands).
5. Fissile material in fuel is difficult to extract	TRISO fuel is difficult to reprocess.	TRISO fuel is difficult to reprocess.
6. Fuel cycle facilities have few points of access to nuclear material, especially in separated form	Fuel blocks are replaced after one cycle of irradiation, no reprocessing.	Fuel cycle facilities mainly involve pebble handling but no reprocessing, and remote operations are required.
7. Fuel cycle facilities can only be operated to process declared feed materials in declared quantities	N/A	N/A
Features preventing or inhibiting undeclared production of direct-use material		
8. No locations in or near the core of a reactor where undeclared target materials could be irradiated	Irradiate target material in moderator blocks or control rod is a possibility. Ton quantities of fertile material needed to generate 1SQ would be difficult to conceal and would affect reactor operation.	The core is an open cavity filled with fuel pebble. There is no space for control rod to hide the target materials. There is no space to hide target pebbles and no means to harvest the target pebbles after irradiation. Proliferator has difficulty to distinguish the target materials from fuel pebble. Ton quantities of fertile material needed to generate 1SQ would be difficult to conceal and would affect reactor operation.
9. The core prevents operation of the reactor with undeclared target materials (e.g. small reactivity margins)	The large number of fuel blocks required to accumulate 1 SQ of Pu makes operation of the reactor with undeclared target easy to detect. It might be possible to replace the control rods with the target materials.	It is easy to detect diversion because the core is designed with little excess reactivity. It is possible to introduce U-238 pebbles for breeding, but would be difficult to carry-out, owing to the large number of pebbles involved.

Summary of PR relevant Intrinsic design features	B-VHTR (General Atomics' GT-MHR, SC-HTGR, OKBM's GT-MHR, GTHTR300C, NHDD)	P-VHTR (Xe-100, HTR-PM)
10. Facilities are difficult to modify for undeclared production of nuclear material	The particle-fuelled reactor is difficult to modify to use other fuel for undeclared production of nuclear material..	The large number of fuel pebbles involved in any undeclared production makes the activity difficult to carry out..
11. The core is not accessible during reactor operation	Not accessible and very high radiation environment.	Not accessible and very high radiation environment.
12. Uranium enrichment plants (if needed) cannot be used to produce HEU	Expect international safeguards in place to deter HEU production.	Expect international safeguards in place to deter HEU production.
Features facilitating verification, including continuity of knowledge		
13. The system allows for unambiguous Design Information Verification (DIV) throughout life cycle	DIV should be straight-forward.	DIV should be straight-forward.
14. The inventory and flow of nuclear material can be specified and accounted for in the clearest possible manner	Fuel blocks are amenable to item-counting.	Fuel pebbles are treated in bulk for accounting. Although it is in a closed system, nuclear material in the pebbles always move due to online refueling through a pipe.
15. Nuclear materials remain accessible for verification the greatest practical extent	Fuel blocks are identifiable by serial numbers. However, since there is no water shielding like LWRs, inspectors cannot directly see the fuel block loaded in the core.	Verification of pebbles may pose challenges.
16. The system makes the use of operation and safety/related sensors and measurement systems for verification possible, taking in to account the need for data authentication	Radiation monitors and interlocks for fuel transfer machinery can also be used for safeguards.	Measurement systems needed to count and authenticate fuel pebbles for operation can also be used for safeguards. Devices that measure the reactivity and the burnup will also be important for safeguards.
17. The system provides for the installation of measurement instruments, surveillance equipment and supporting infrastructure likely to be needed for verification	System elements are similar to LWRs and should be amendable to installation of safeguards equipment..	Though system elements are similar to LWRs fuel accounting is different and item counting is not practical. The system is a candidate for the application of safeguards-by-design.

THE GENERATION IV INTERNATIONAL FORUM

Established in 2001, the Generation IV International Forum (GIF) was created as a co-operative international endeavor seeking to develop the research necessary to test the feasibility and performance of fourth generation nuclear systems, and to make them available for industrial deployment by 2030. The GIF brings together 13 countries (Argentina, Australia, Brazil, Canada, China, France, Japan, Korea, Russia, South Africa, Switzerland, the United Kingdom and the United States), as well as Euratom – representing the 27 European Union members and the United Kingdom – to co-ordinate research and develop these systems. The GIF has selected six reactor technologies for further research and development: the gas-cooled fast reactor (GFR), the lead-cooled fast reactor (LFR), the molten salt reactor (MSR), the sodium-cooled fast reactor (SFR), the supercritical-water-cooled reactor (SCWR) and the very-high-temperature reactor (VHTR).

A report produced by



www.gen-4.org

PRPPWG

Proliferation Resistance and Physical Protection Working Group